



**VIKTOR**  
SURGICAL INSTRUMENTS

**2019**

Dental, Veterinary and Manicure Instruments

**SECTION**  
**ORTHOPEDIC INSTRUMENTS**

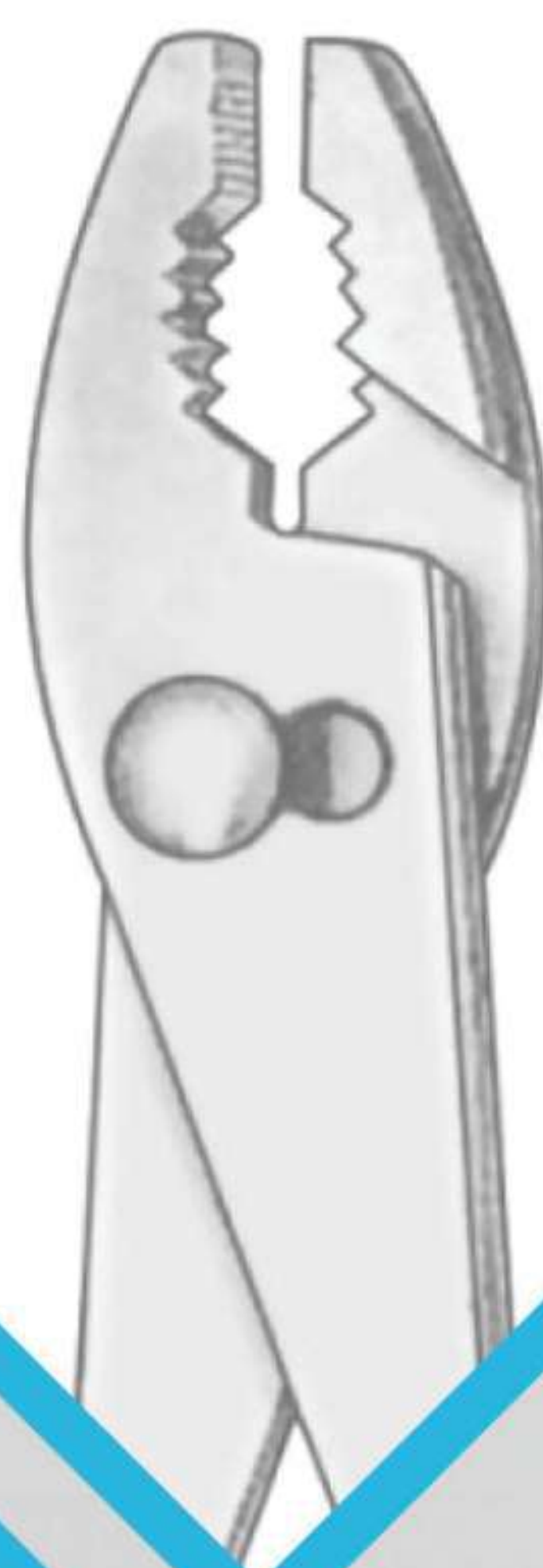
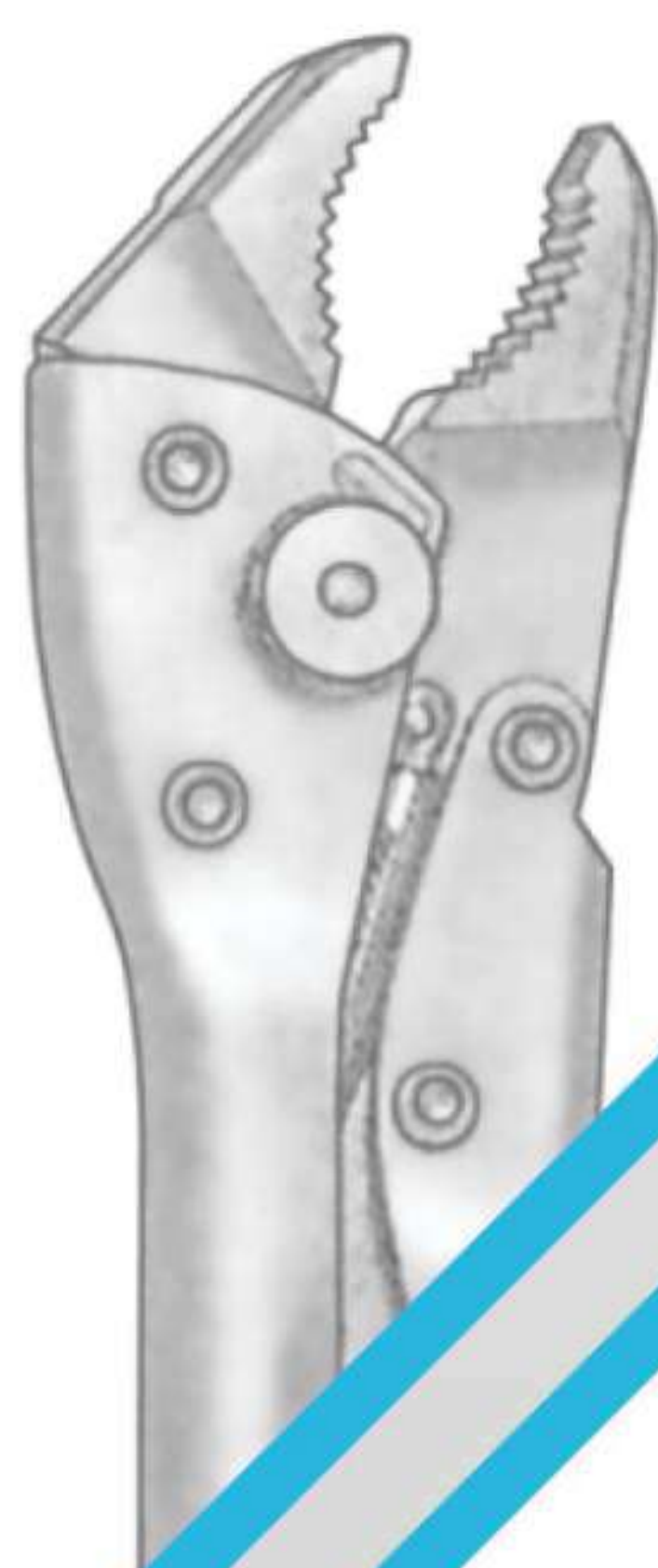
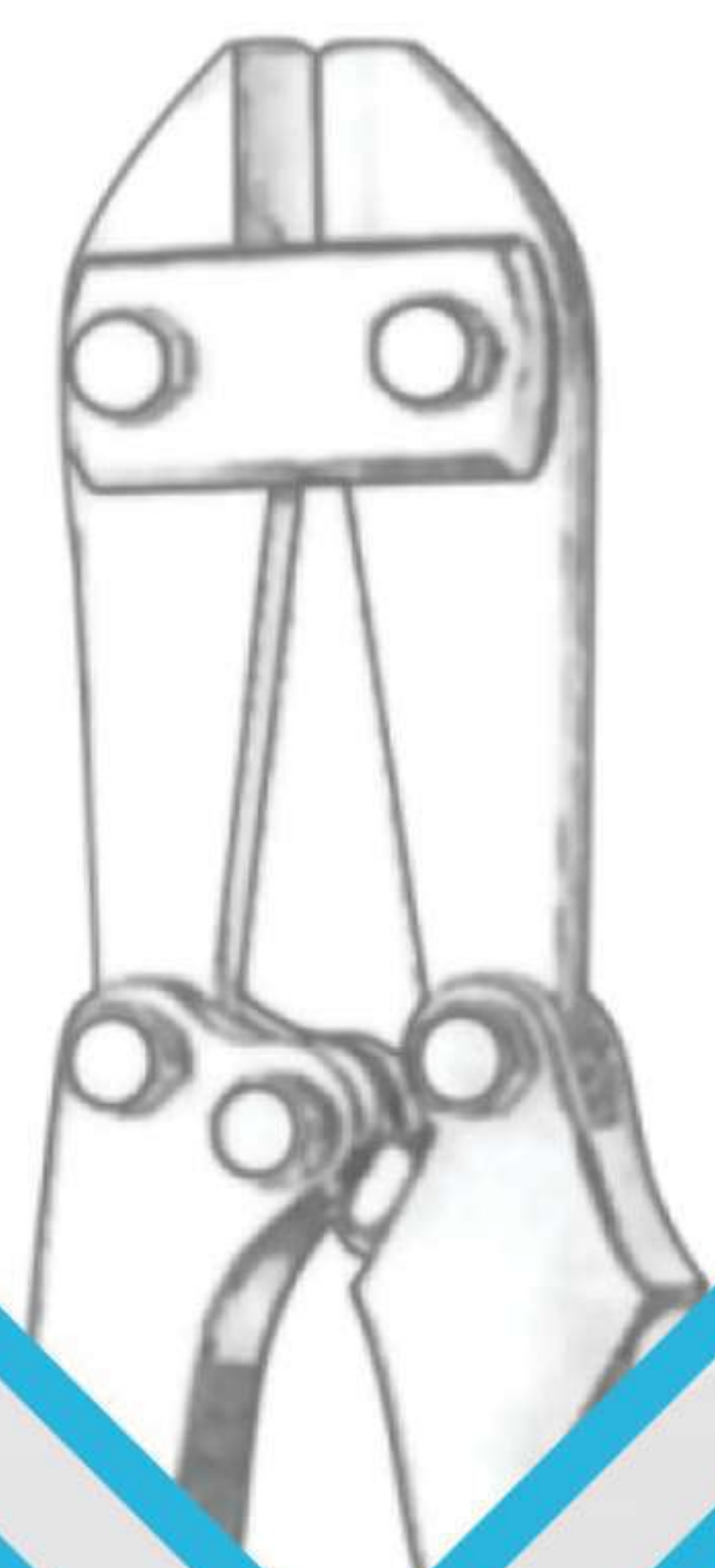
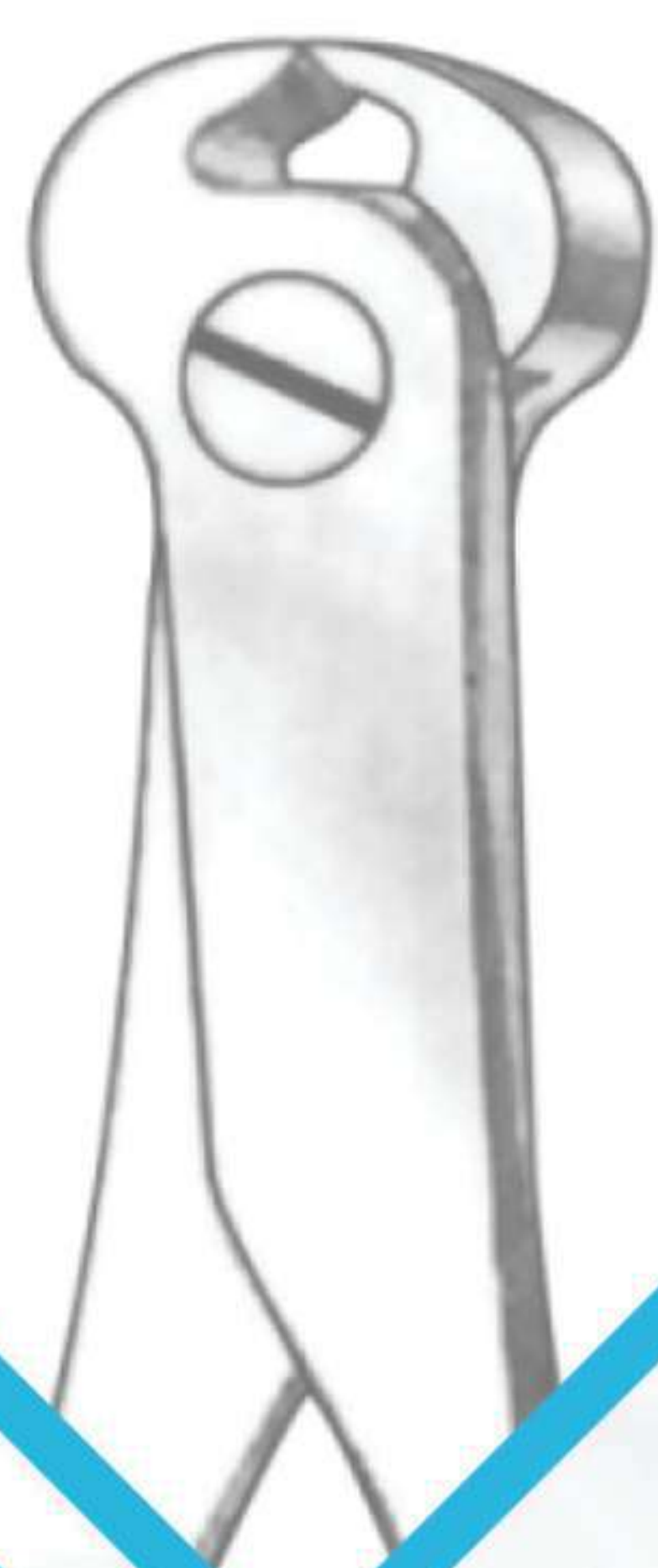
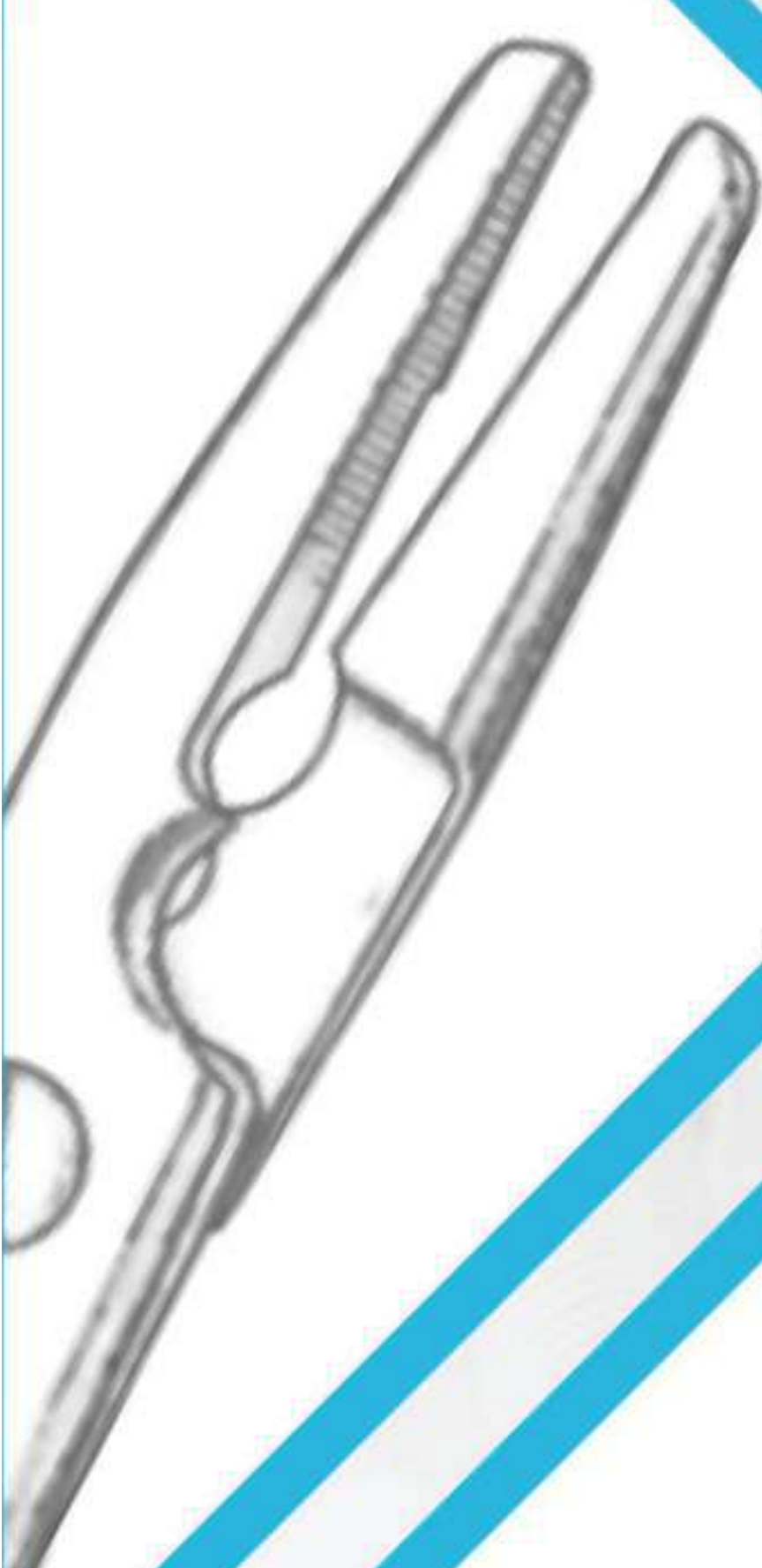



## Pin Cutter and Wire Cutters

190

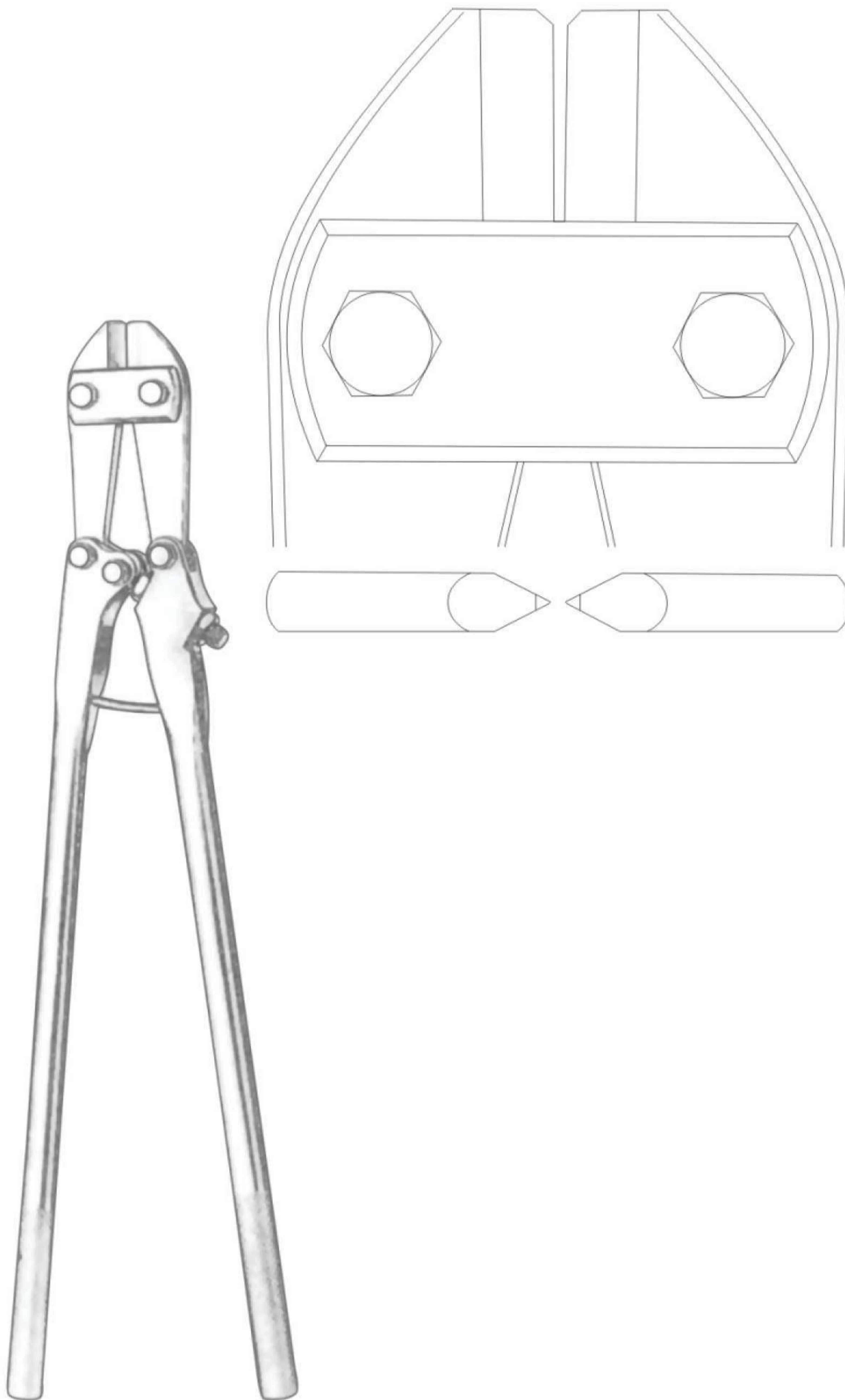

**Large Pin Cutter**  
 190-1457  
 55.6 cm / 22  
 cut rods up to .250" (6.3mm),  
 toggle joint transfers leverage to the cutting blades



**Cannulated Pin Cutter**  
 190-1458  
 19.0 cm / 7½", end cutting  
 maximum.062" (1.6mm)





**Needle Nose Pliers**  
191-1459  
14.0 cm / 5½", grooved jaws,  
tips taper to 1mm

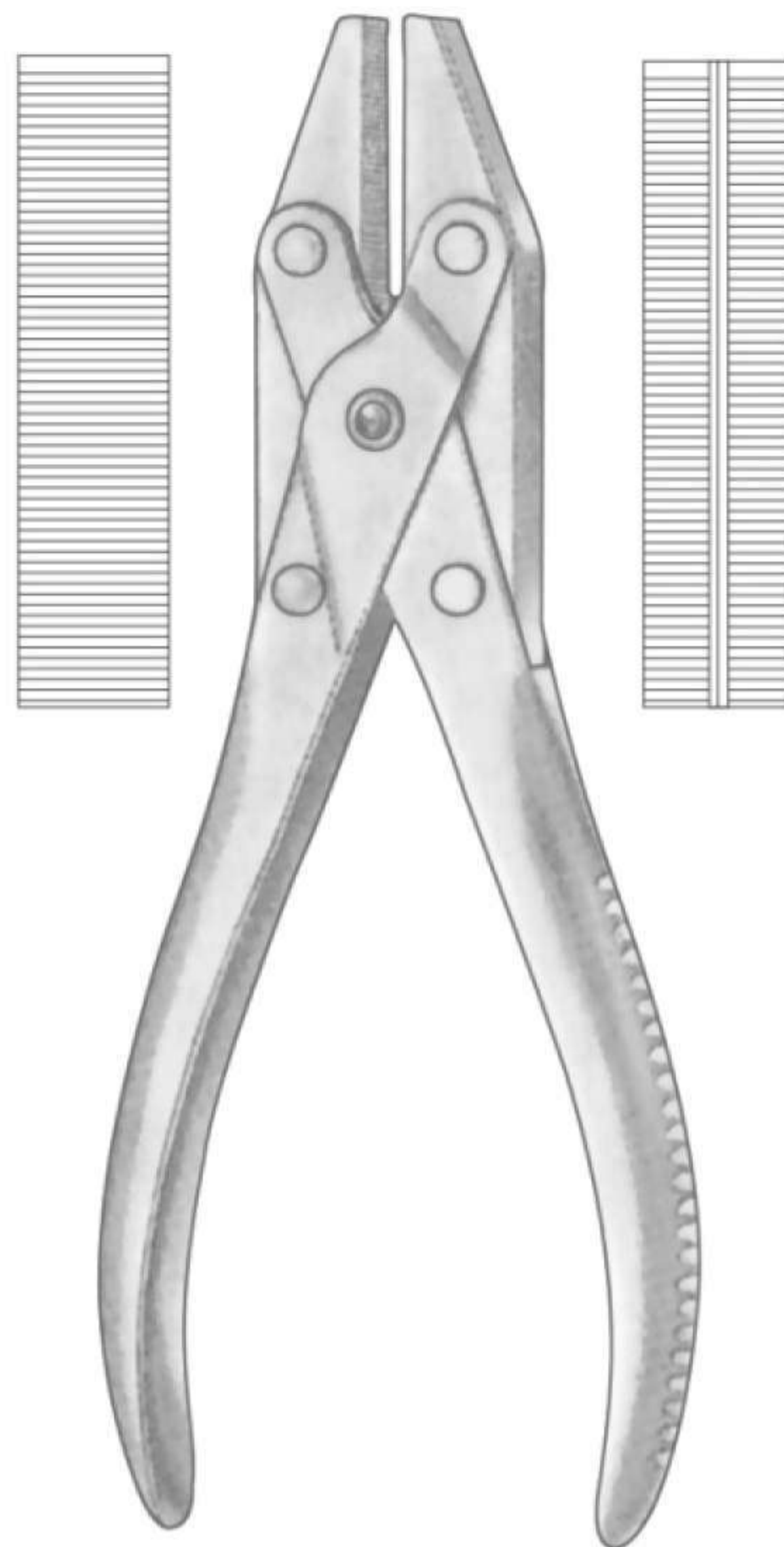

**Parallel Pliers**  
191-1460  
18.0 cm / 7", grooved 10 mm wide jaws  
for pin removal

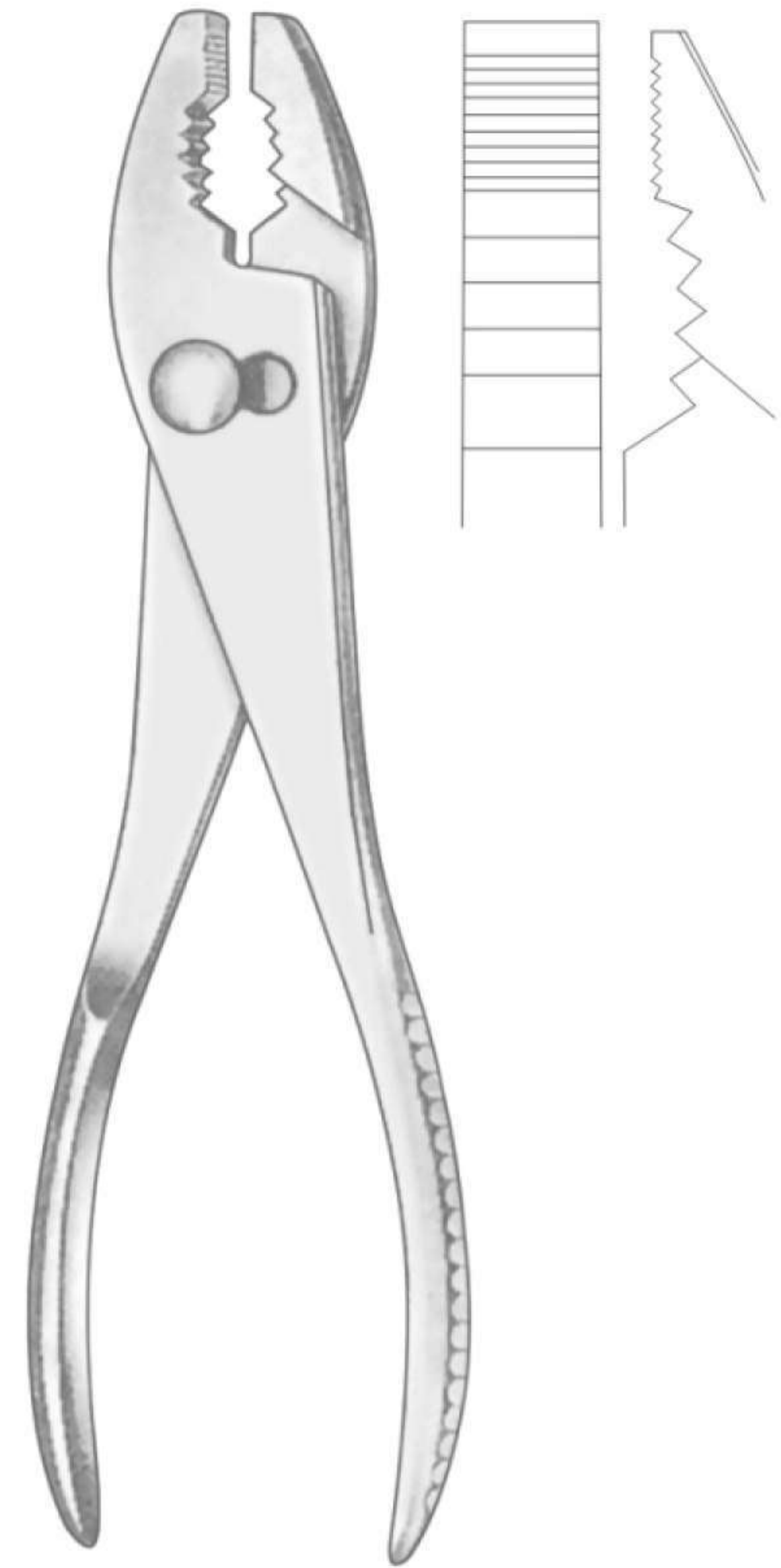

**Slip Joint Adjustable Pliers**  
191-1461  
19.7 cm / 7¾"



## Pliers

192

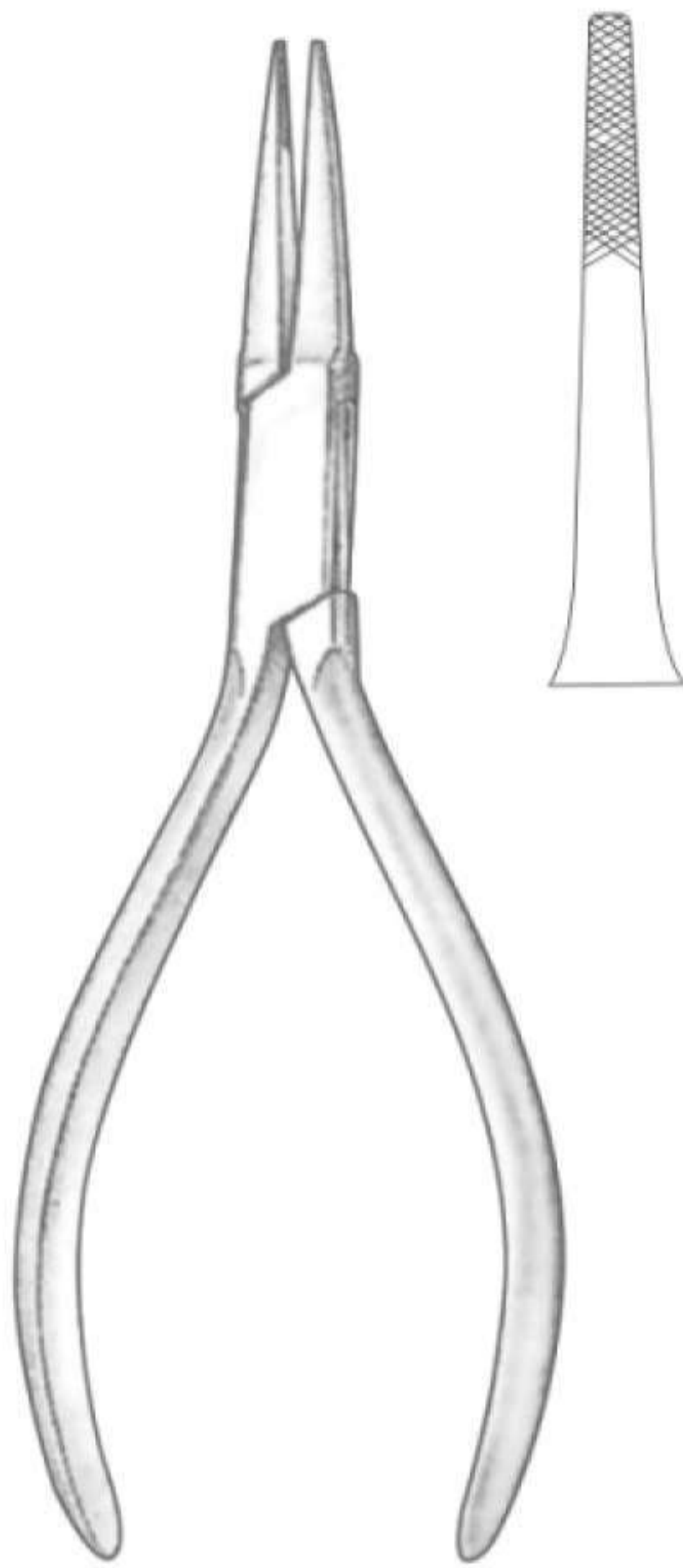

**Flat Nose Pliers**  
 192-1462  
 15.0 cm / 6", tips taper to 2mm

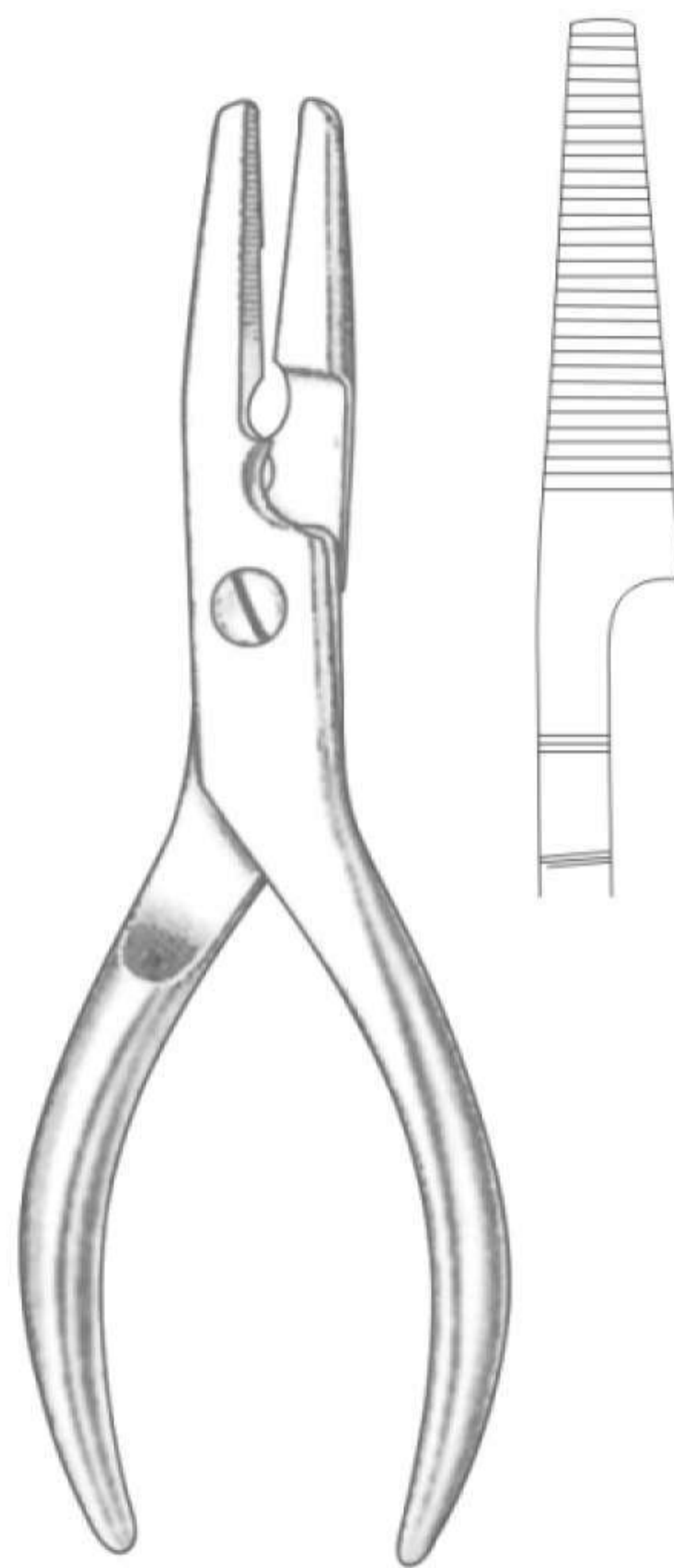

**Flat Nose Pliers**  
 192-1463  
 16.5 cm / 6½", side cutting blades  
 tips taper to 3.5 mm

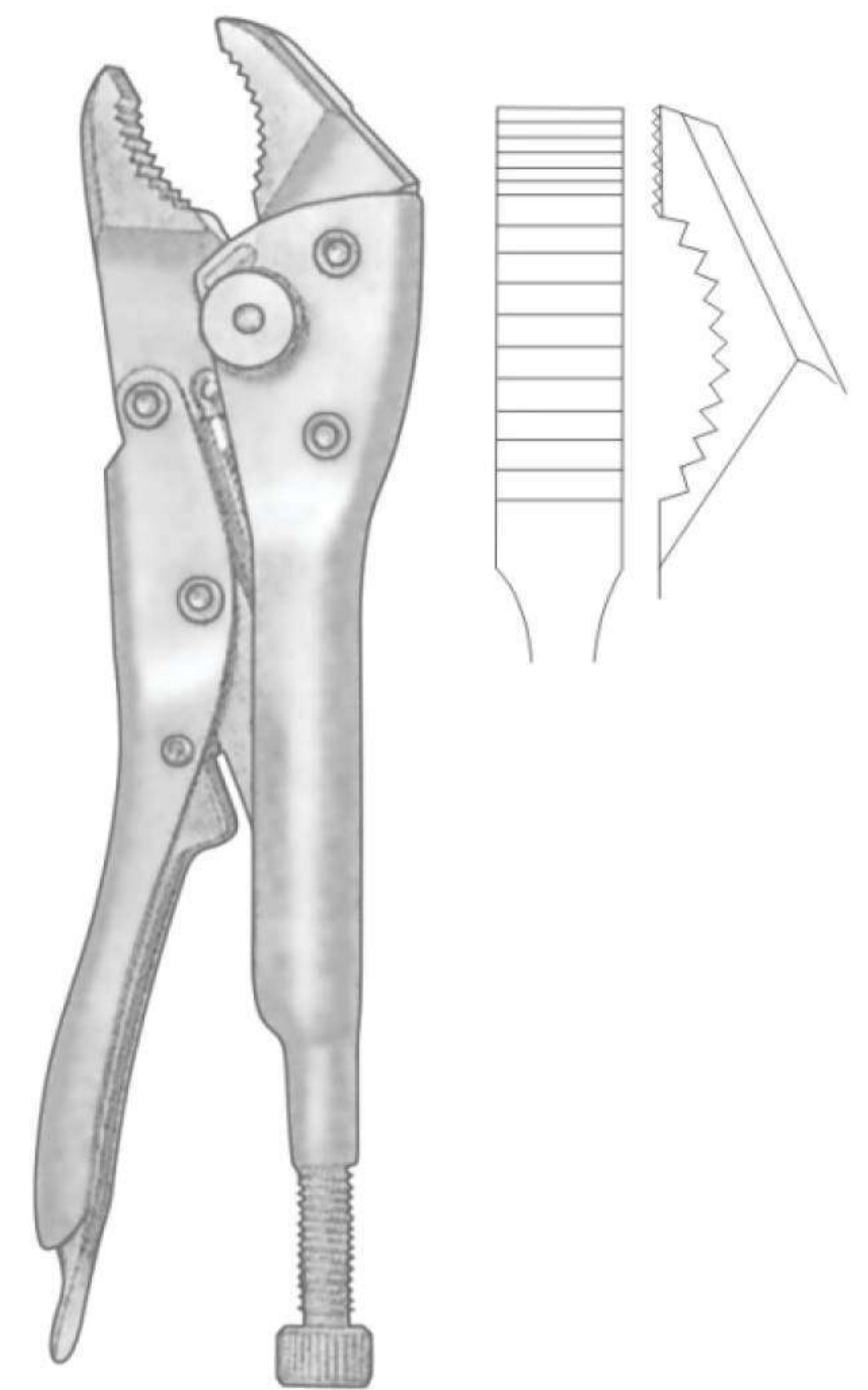

**Heavy Duty Locking Pliers**  
 192-1464  
 17.0 cm / 6¾" 7mm wide tip  
 reinforced jaw hinge, self-locking lever with  
 adjustment screw and one-handed quick release



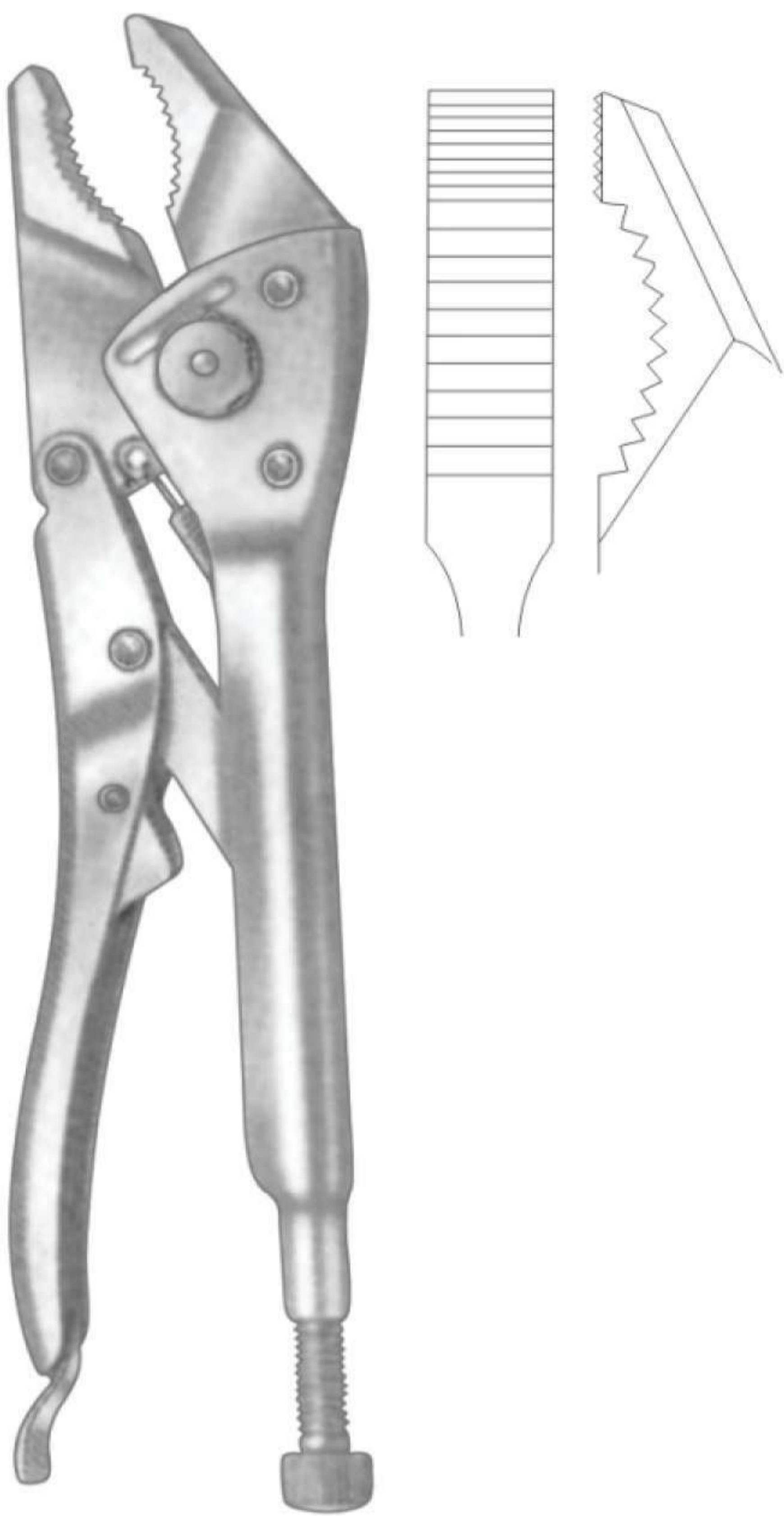

**Heavy Duty Locking Pliers**  
193-1465  
20.0 cm / 8" 9mm wide tip  
reinforced jaw hinge,  
self-locking lever with adjustment  
screw and one-handed quick release

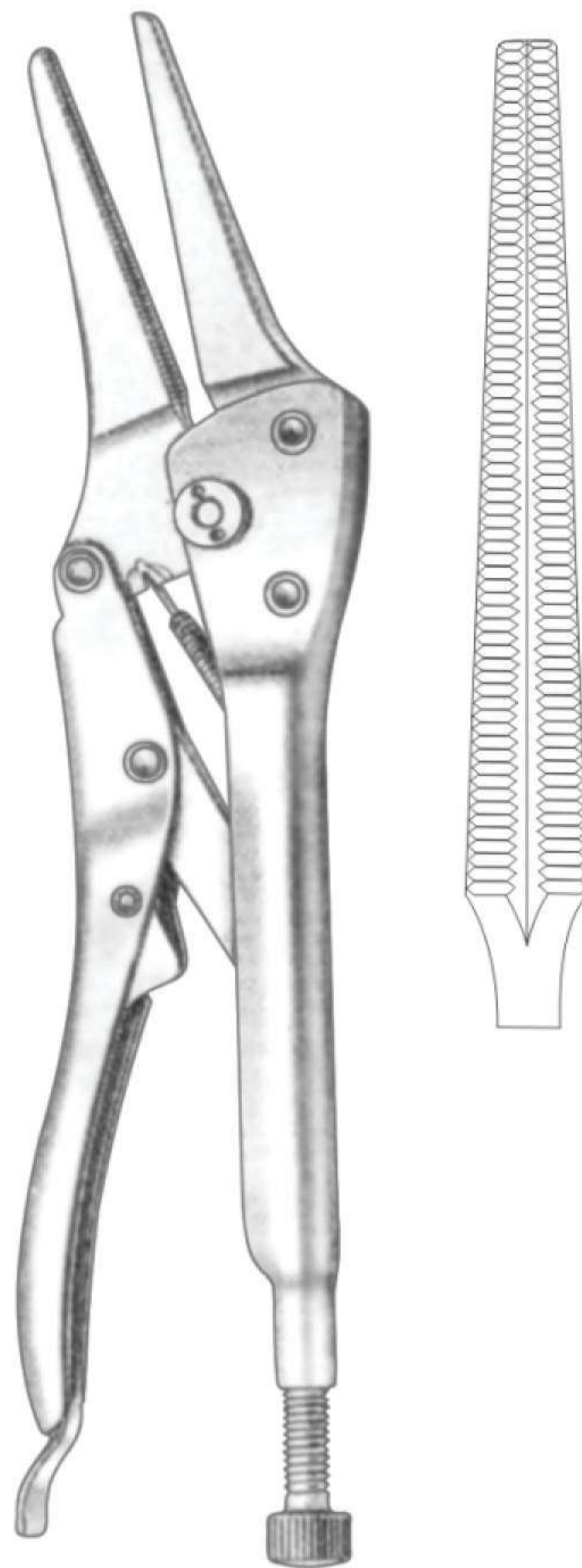

**Heavy Duty Locking Pliers**  
193-1466  
24.0 cm / 9½" 5mm wide tip  
reinforced jaw hinge,  
self-locking lever with adjustment  
screw and one-handed quick release



**Townley Femur Caliper**  
193-1467  
11.5 cm / 4½"





**VIKTOR**

SURGICAL INSTRUMENTS

**Head Office:**

533 Keswick Ct Rocheter Hills Michigan USA 48306

**UAE Office:**

NexGen Gadgets FZE, SM-Oce-C1- 518G, Ajman Free Zone

**South East Asia Office:**

324/34 Samprawuth Rd, Bangna, Bangna Bangkok 10260

Tel. : +662 107 4183

Mr.Tony +661 599 6754

E-mail : [tony@viktormedical.com](mailto:tony@viktormedical.com)