



VIKTOR
SURGICAL INSTRUMENTS

2019

Dental, Veterinary and Manicure Instruments

SECTION
GYNECOLOGY INSTRUMENTS



Vaginal Specula

363

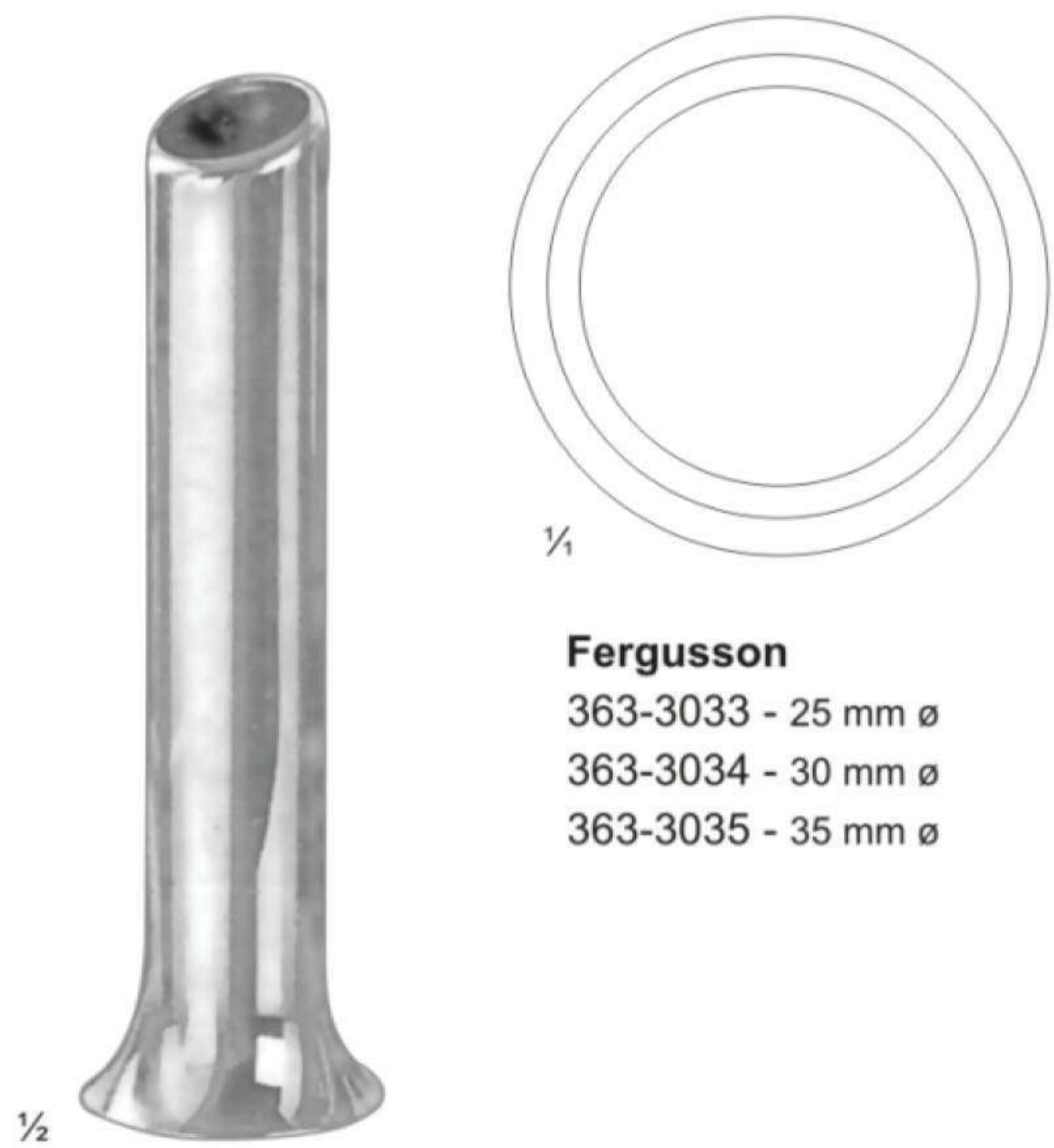

Fergusson

- 363-3033 - 25 mm ø
- 363-3034 - 30 mm ø
- 363-3035 - 35 mm ø

1/2
Metal Specula, tubular shape

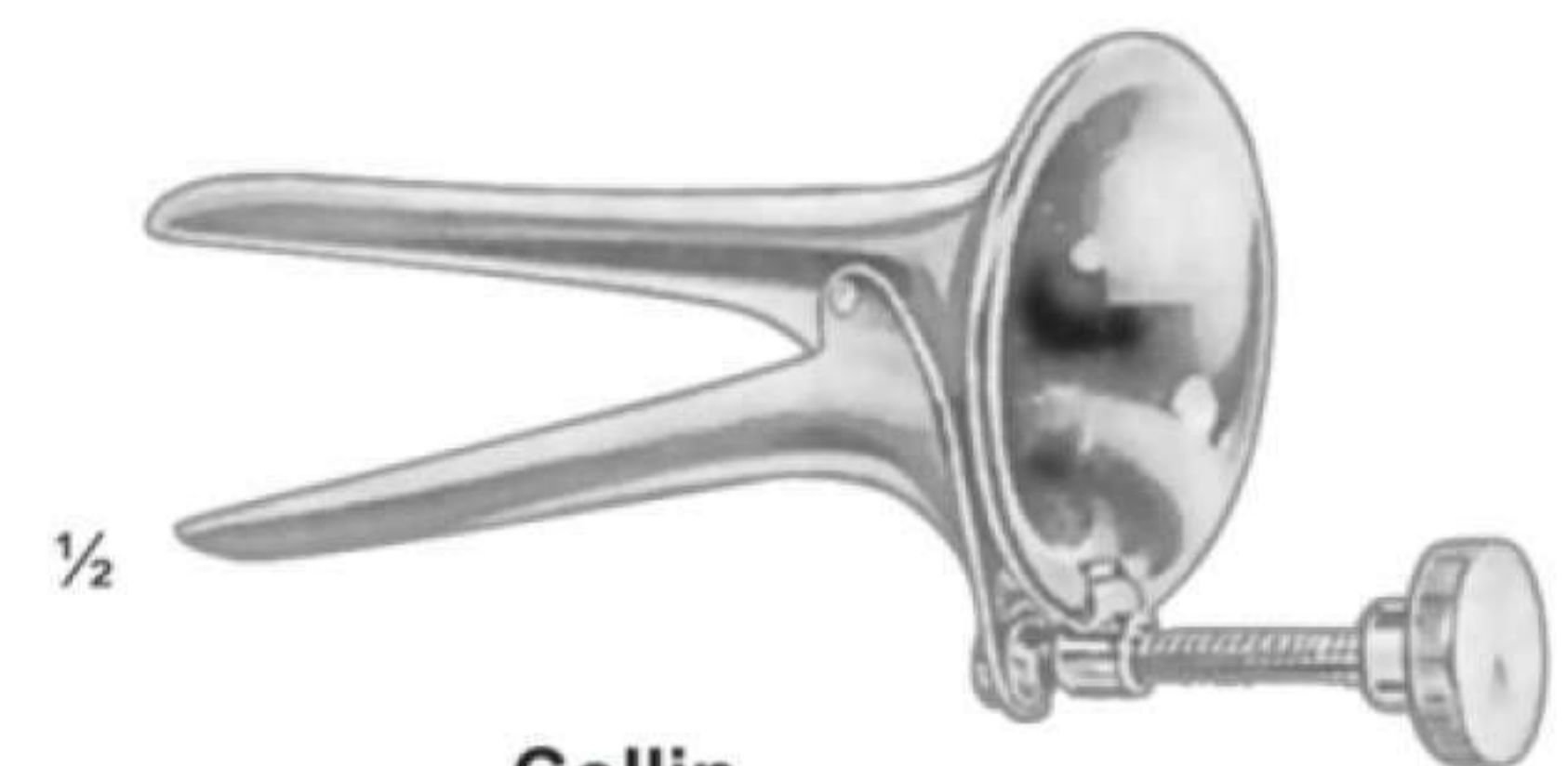

Collin

- 363-3036
- 55 x 10 mm



Cusco

- 363-3037 - 75 x 32 mm
- 363-3038 - 85 x 35 mm
- 363-3039 - 100 x 35 mm
- Vaginal Specula with lateral ratchet, with folding handles

- 363-3040 - 85 x 35 mm
- with interchangeable fiber optic light carrier
- fiber optic light carrier



Cusco

- 363-3041
- 75 x 17 mm
- conical shape, virgin size

Cusco

- 364-3042 - 80 x 22 mm
- 364-3043 - 100 x 25 mm
- 364-3044 - 105 x 27 mm

Swiss pattern, narrow, with lateral ratchet, with folding handles



Cusco

- 364-3045 - 75 x 32 mm
- 364-3046 - 85 x 35 mm
- 364-3047 - 100 x 37 mm

with ratchet at the folding handles

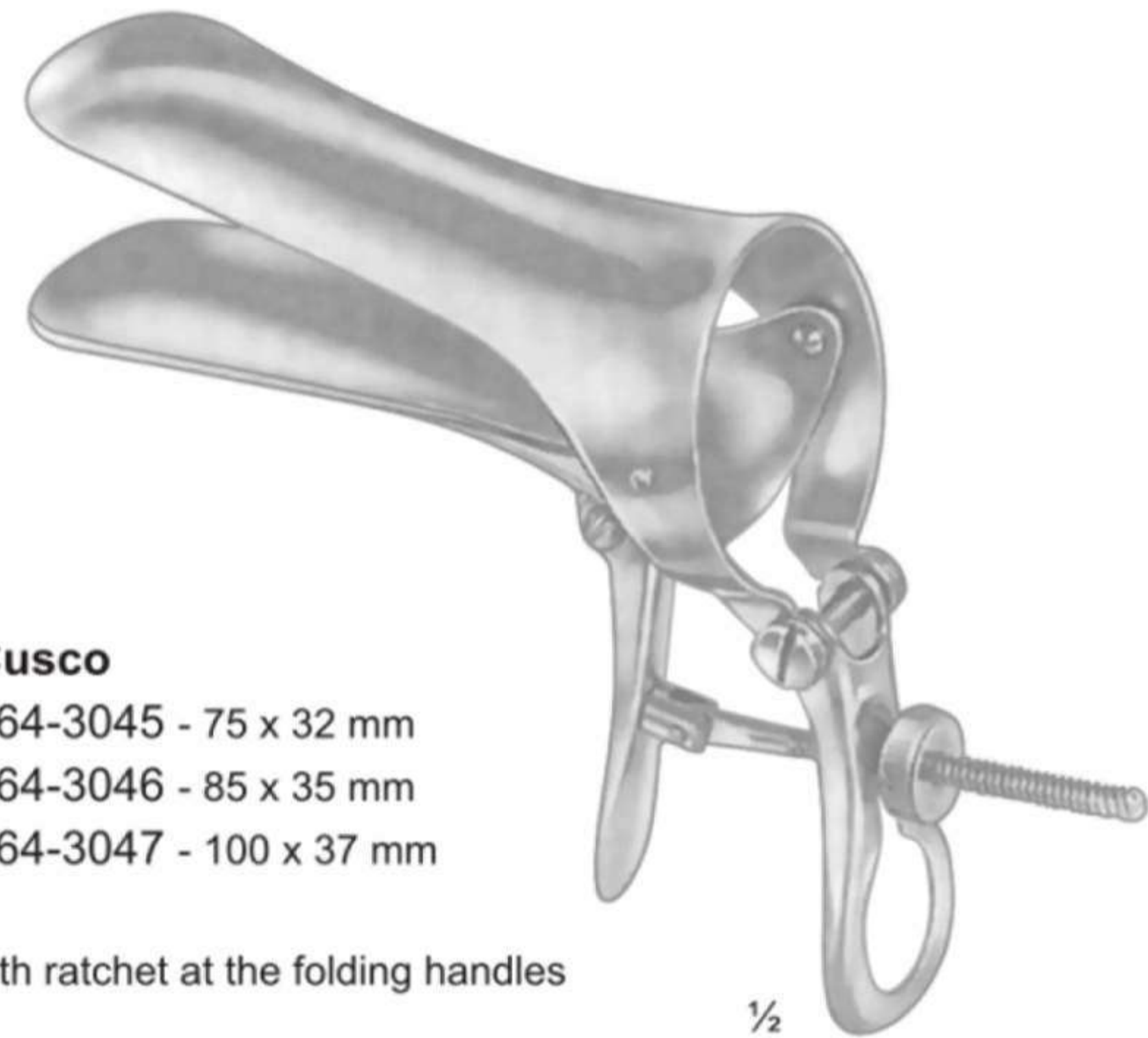

1/2

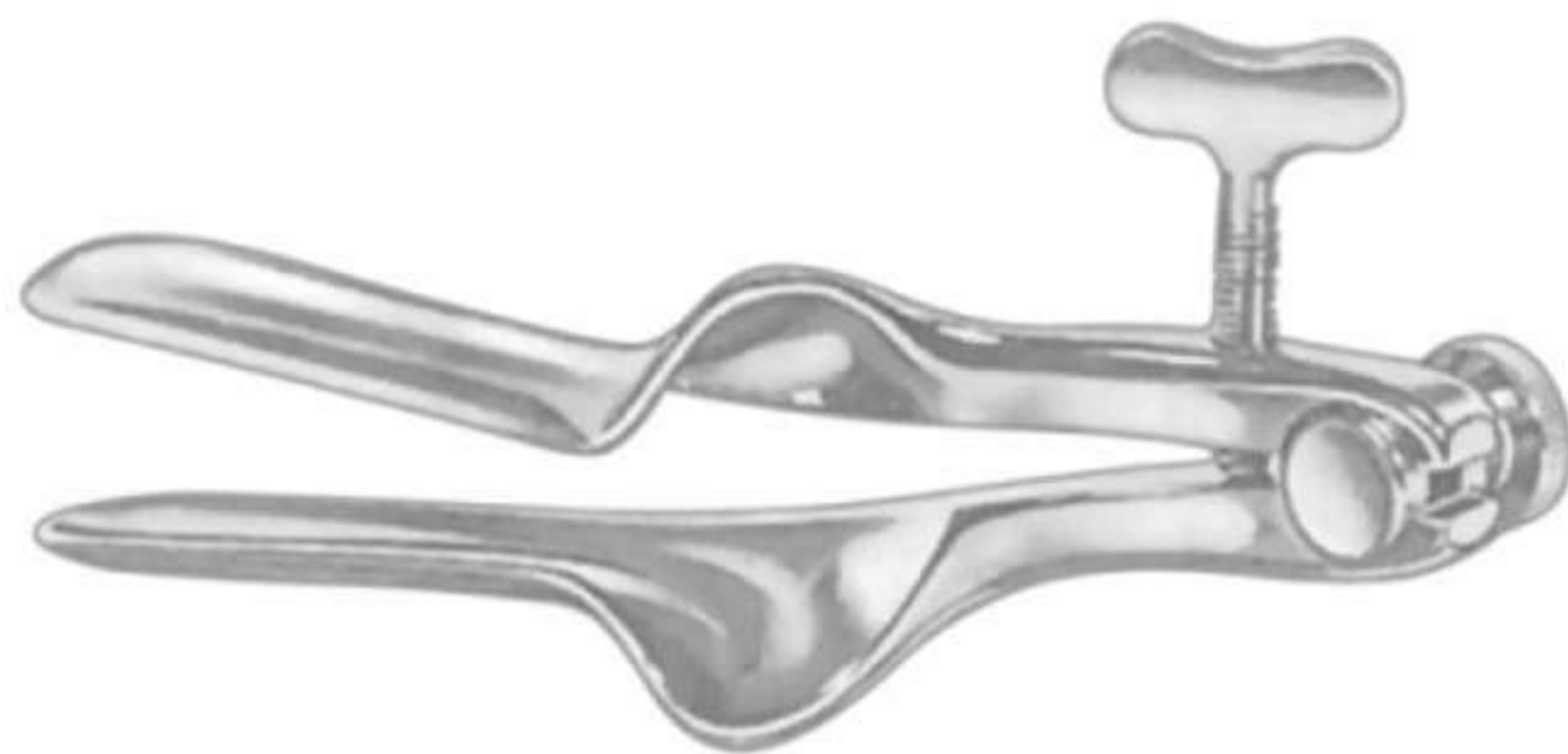

Collin

- 364-3048
- 65 x 20 mm

Collin

- 364-3049 - 85 x 30 mm
- 364-3050 - 100 x 35 mm
- 364-3051 - 110 x 40 mm
- 364-3052 - 100 x 35 mm

Detachable
with interchangeable fibere optic light carrier

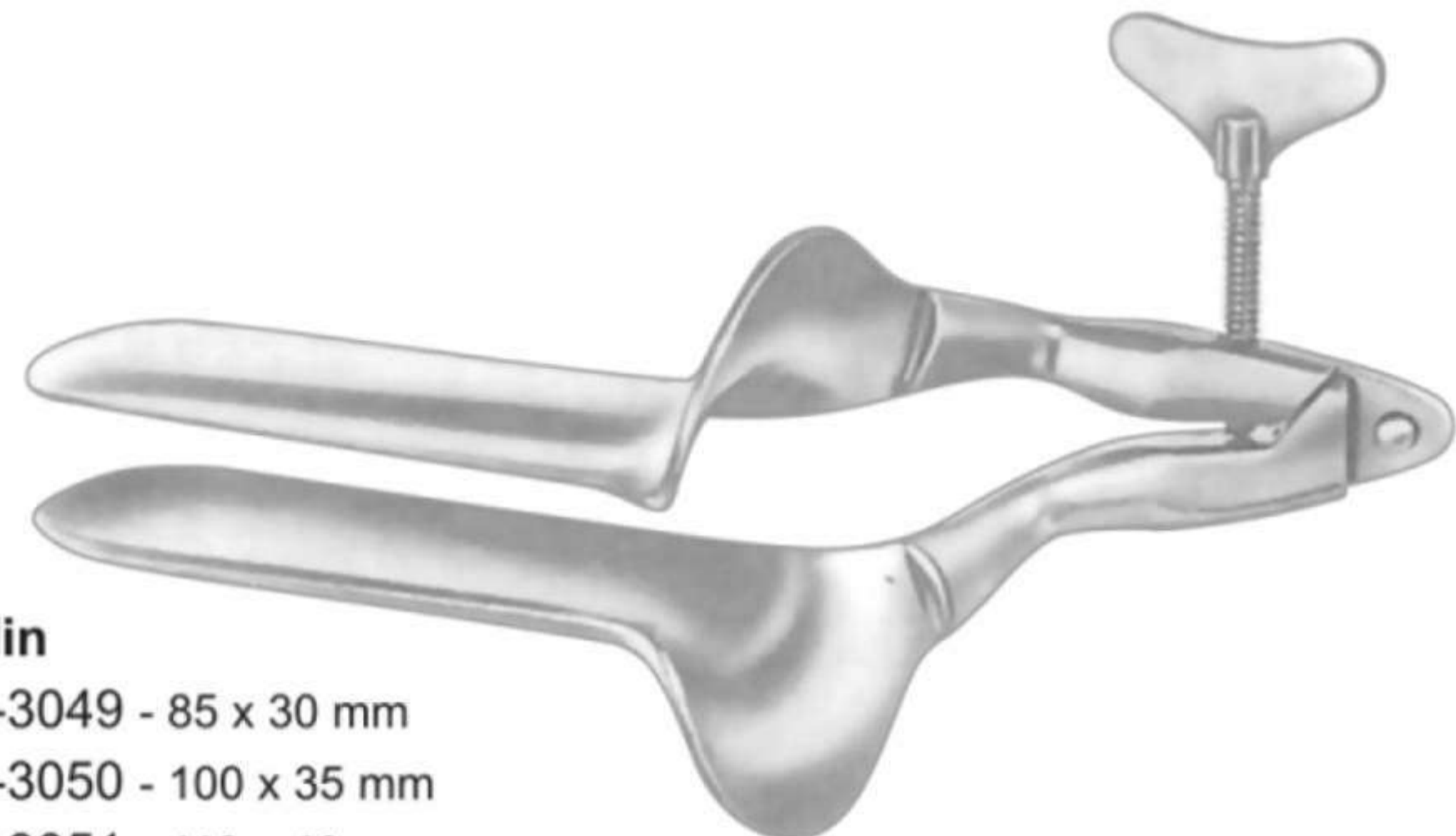

1/2

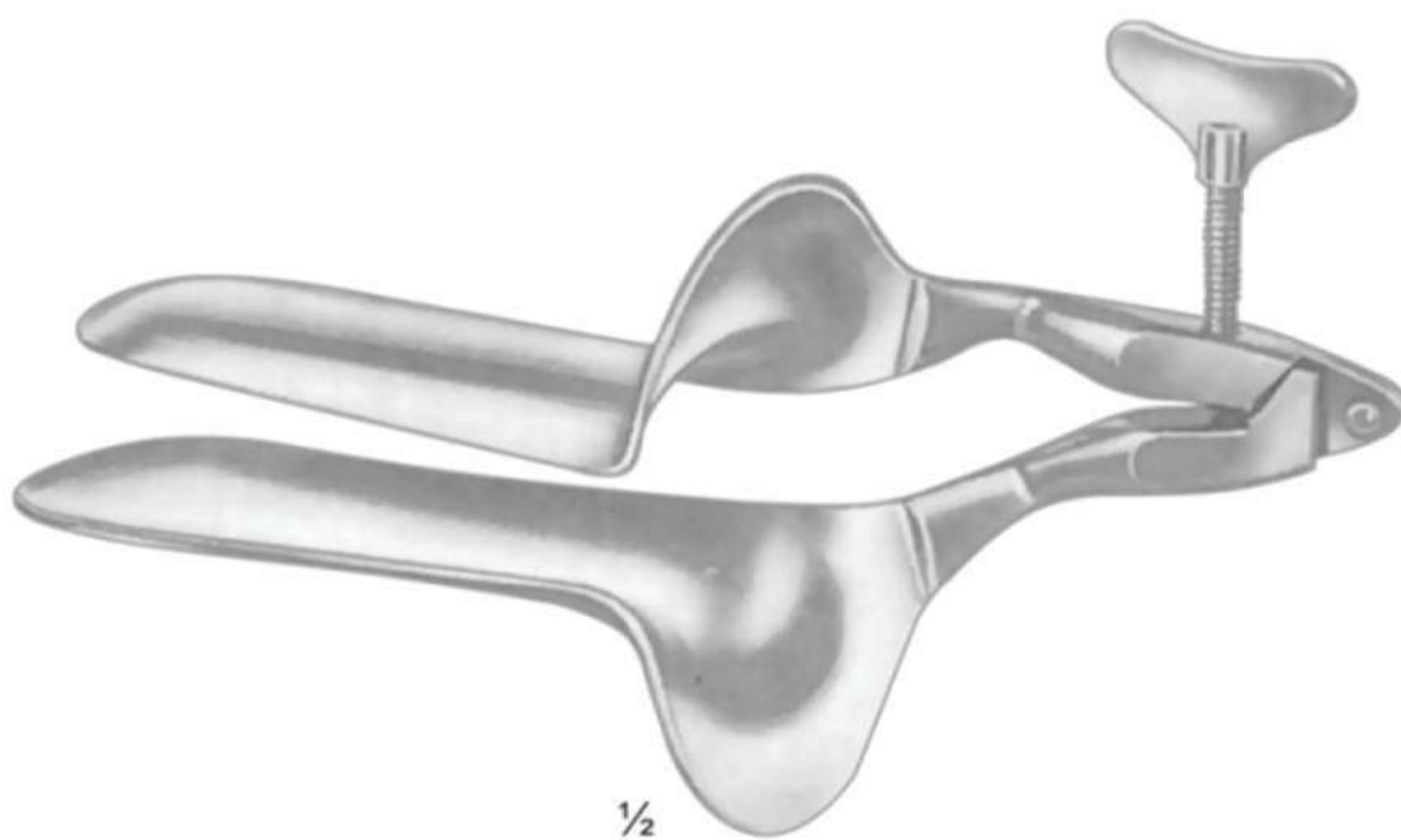

Collin-Lanau

- 364-3053
- 100 x 35 mm

Trelat

- 364-3054 - 85 x 33 mm
- 364-3055 - 95 x 35 mm
- 364-3056 - 115 x 43 mm

detachable, with folding handles

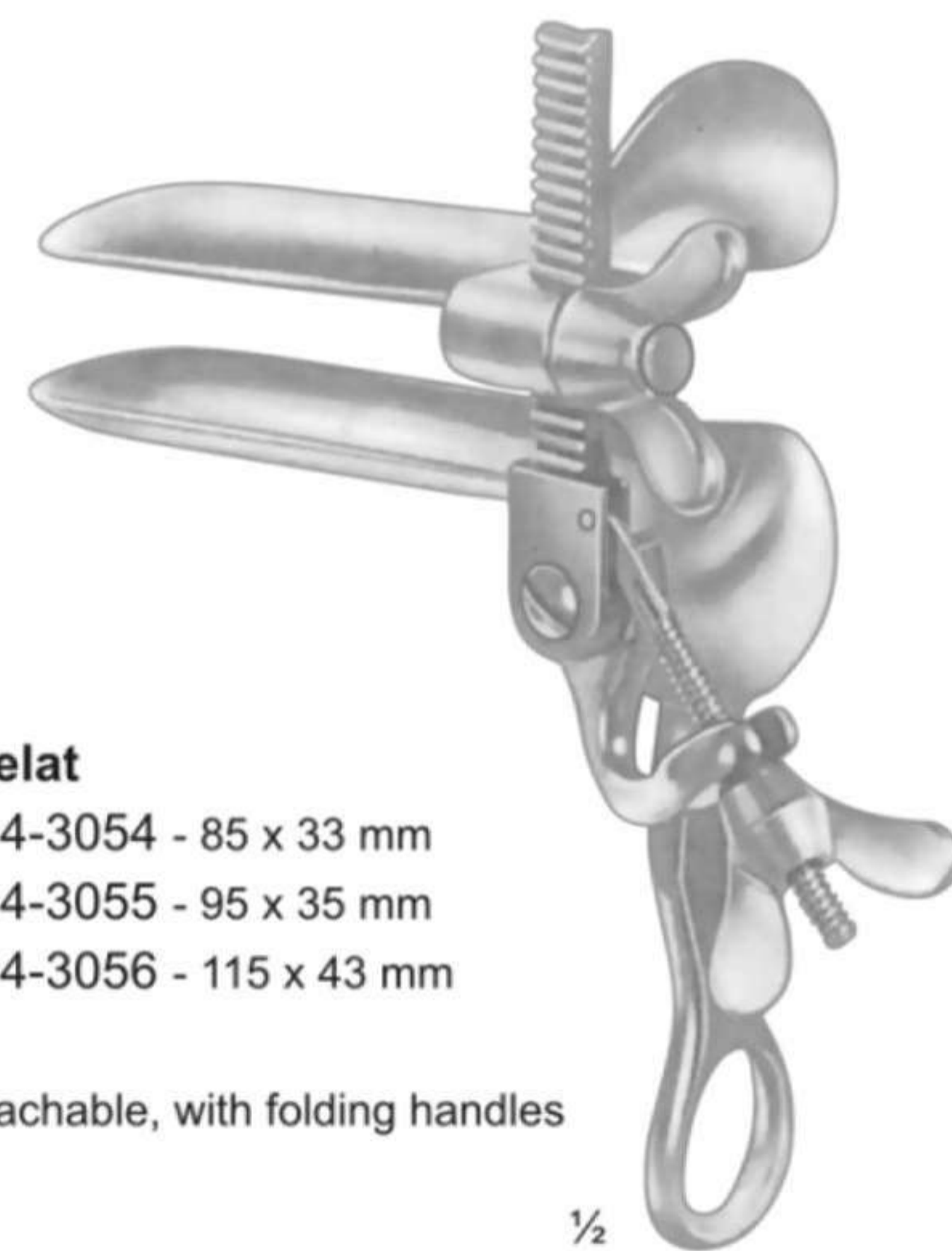

Vaginal Specula

365

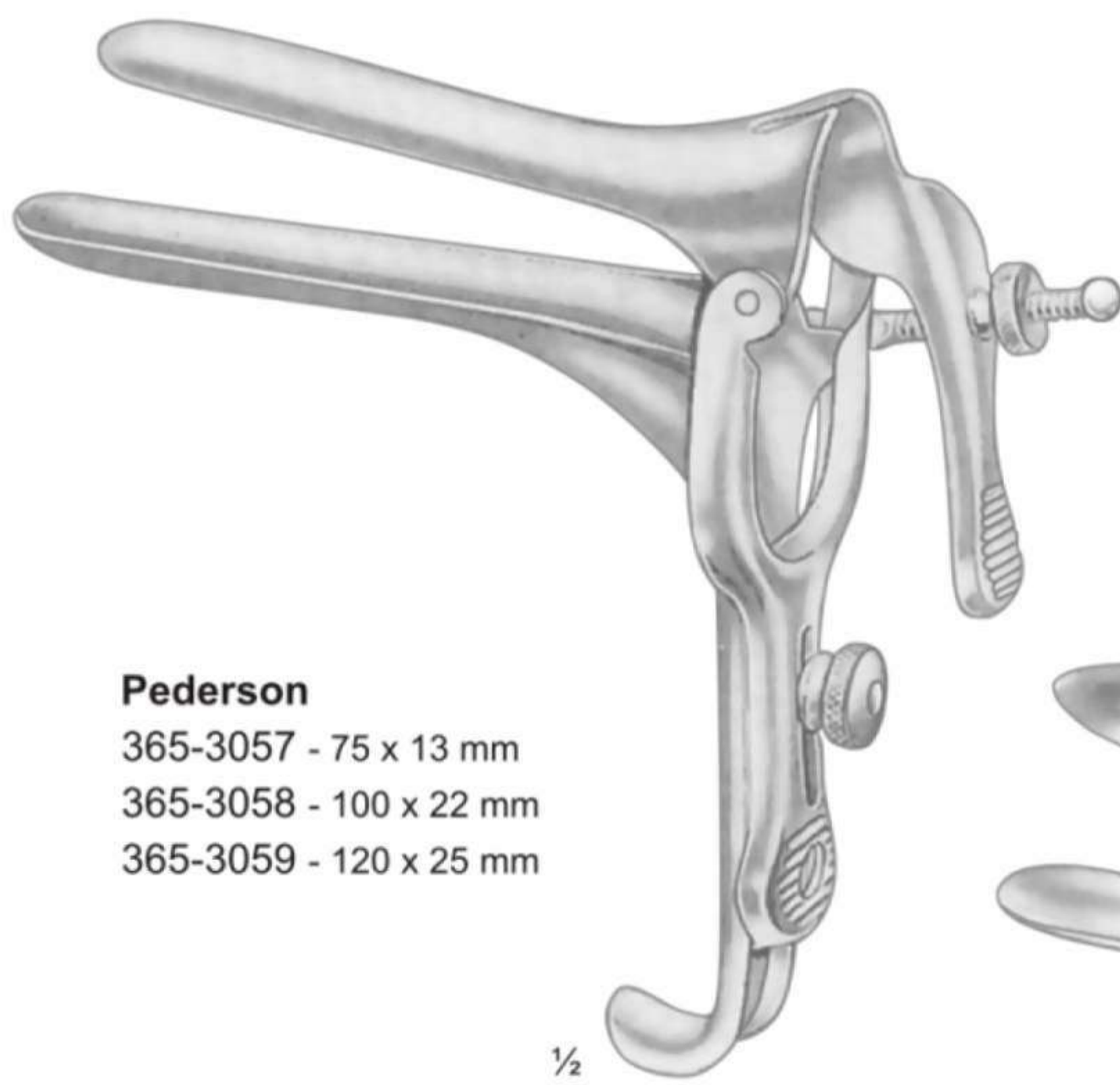

Pederson
 365-3057 - 75 x 13 mm
 365-3058 - 100 x 22 mm
 365-3059 - 120 x 25 mm

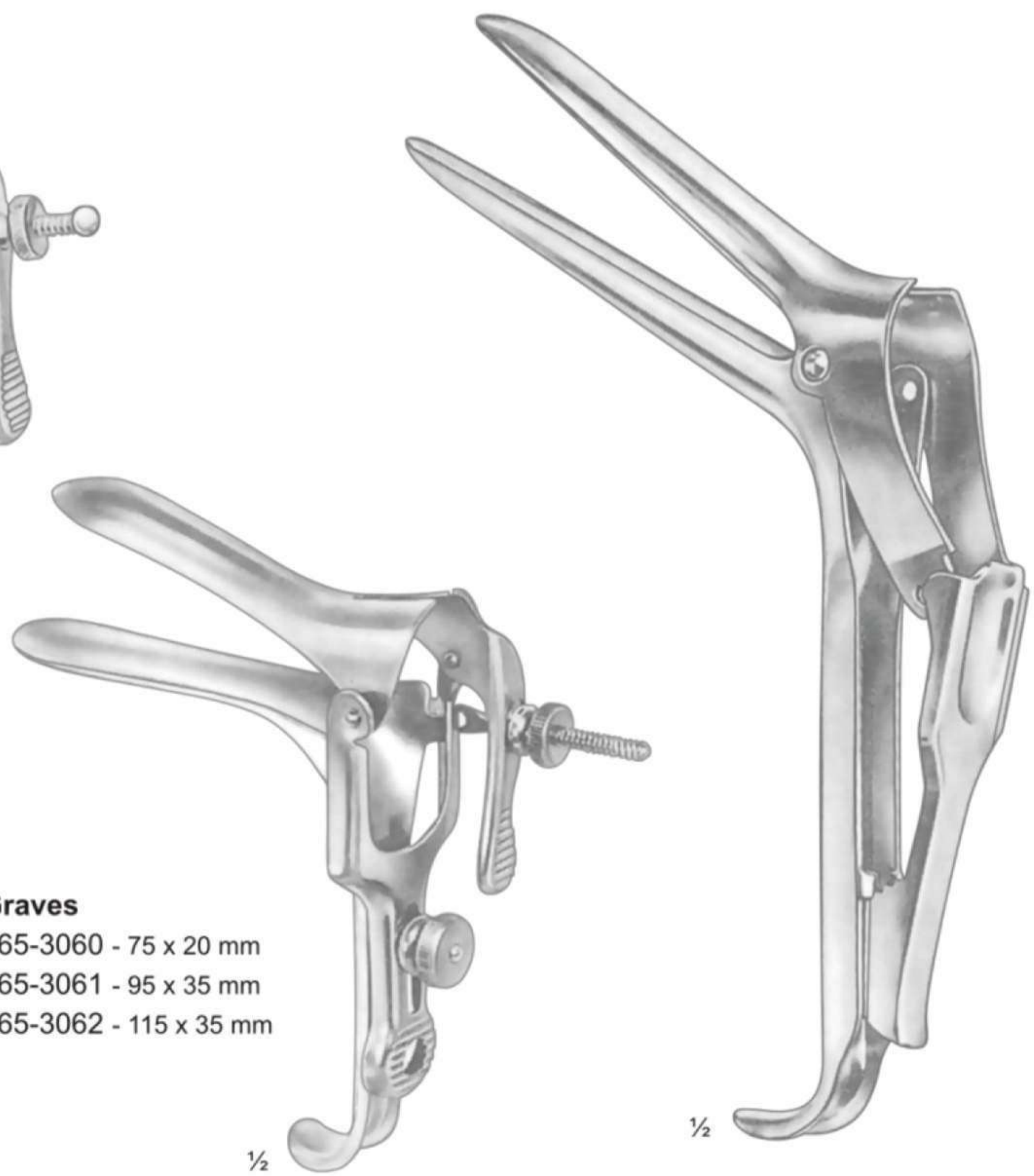

Graves
 365-3060 - 75 x 20 mm
 365-3061 - 95 x 35 mm
 365-3062 - 115 x 35 mm

Semm
 365-3063 - 100 x 17/20 mm
 365-3064 - 100 x 25/30 mm



Kristeller Specula
 Fig.1 365-3065 - 70 x 27 mm
 Fig.2 365-3066 - 80 x 30 mm
 Fig.3 365-3067 - 90 x 36 mm



Kristeller Retractors
 Fig.1 365-3068 - 75 x 23 mm
 Fig.2 365-3069 - 85 x 26 mm
 Fig.3 365-3070 - 100 x 32 mm



Kristeller
 set of 1 speculum
 and 1 retractor each
 Fig.1 365-3071
 Fig.2 365-3072
 Fig.3 365-3073

Vaginal Specula

367

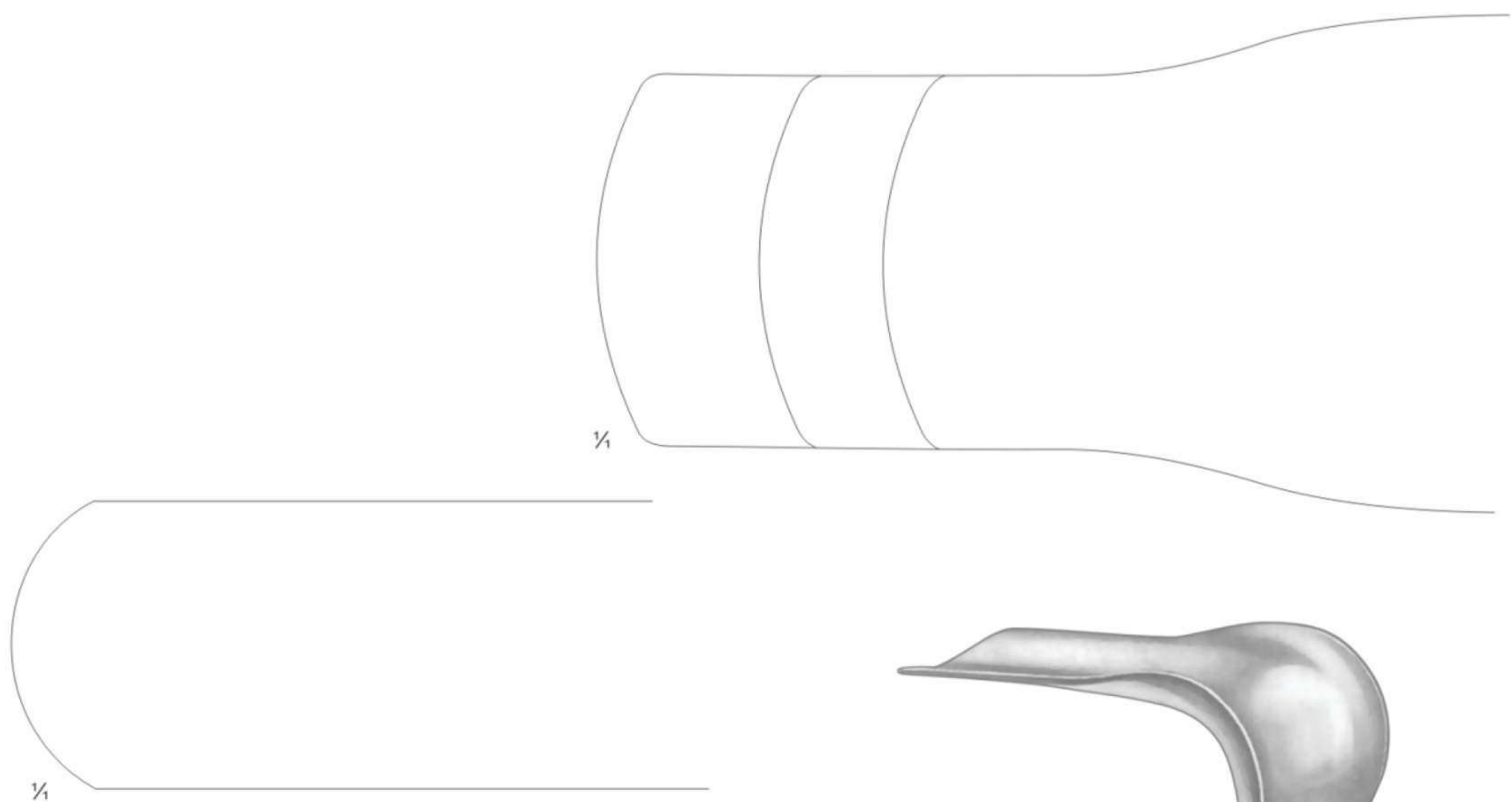
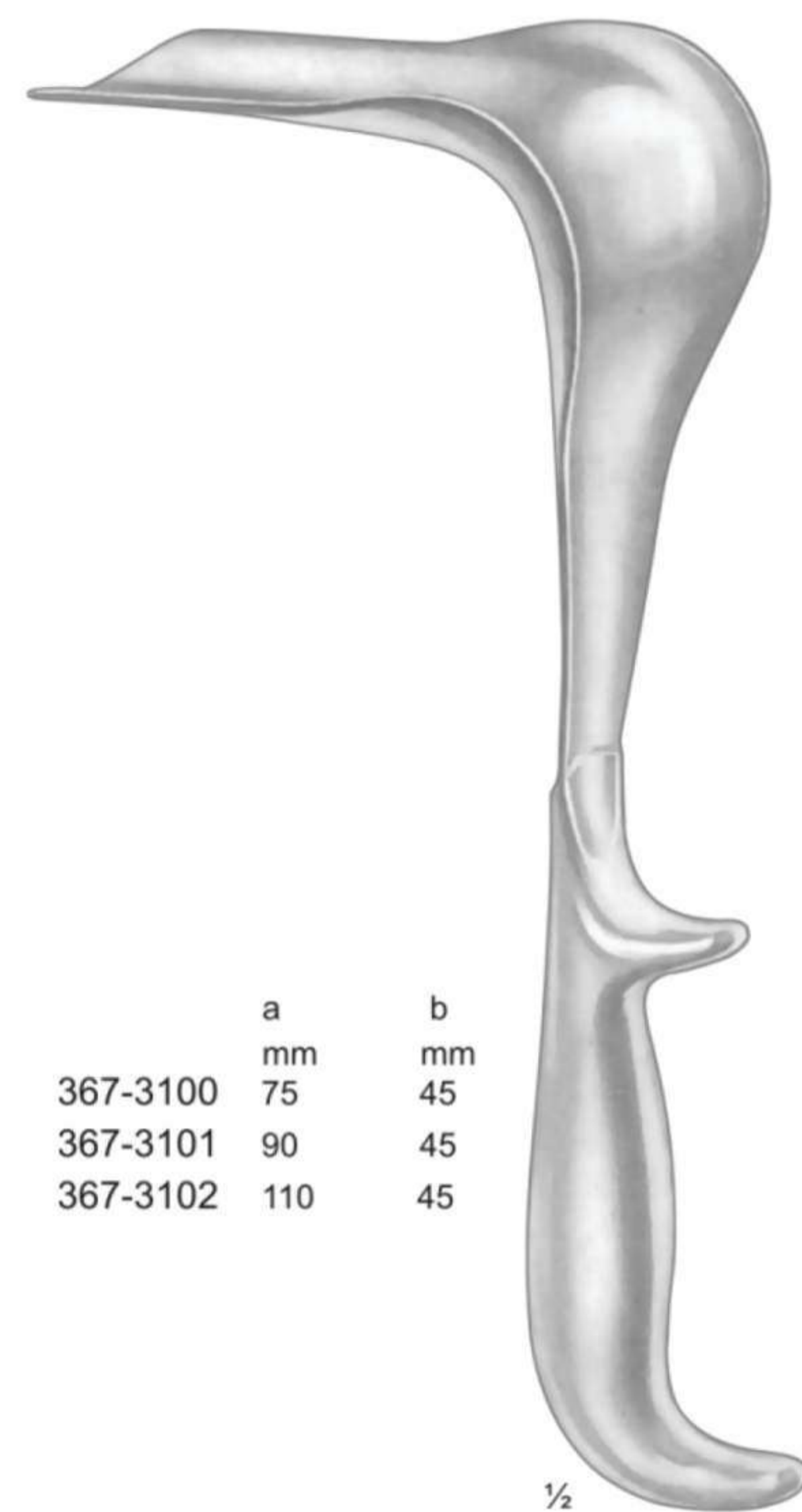

Fig.	slightly-concave	a	b
		mm	mm
1	367-3089	55	35
2	367-3090	58	35
3	367-3091	115	35
1	367-3092	55	45
2	367-3093	85	45
3	367-3094	115	45
4	367-3095	160	45



Doyen

Fig.		a	b
		mm	mm
1	367-3100	75	45
2	367-3101	90	45
3	367-3102	110	45



Doyen

368

Vaginal Specula

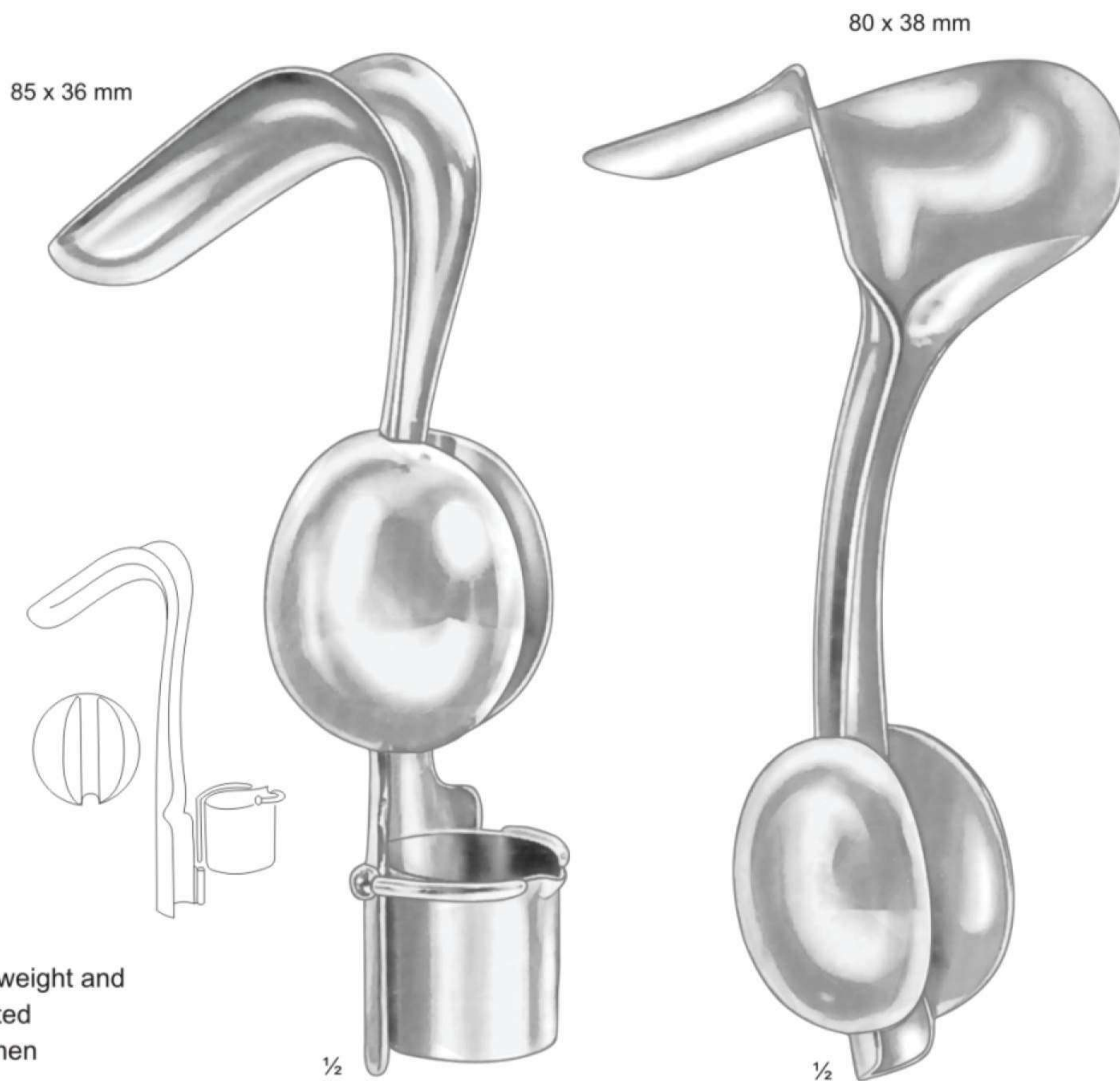

Samuel
368-3103
complete, with removable weight and metal strainer with perforated bottom for retaining specimen

Samuel

Auvard
368-3105

complete, with removable weight

Vaginal Speculum, Retractors

369

70 x 30 mm

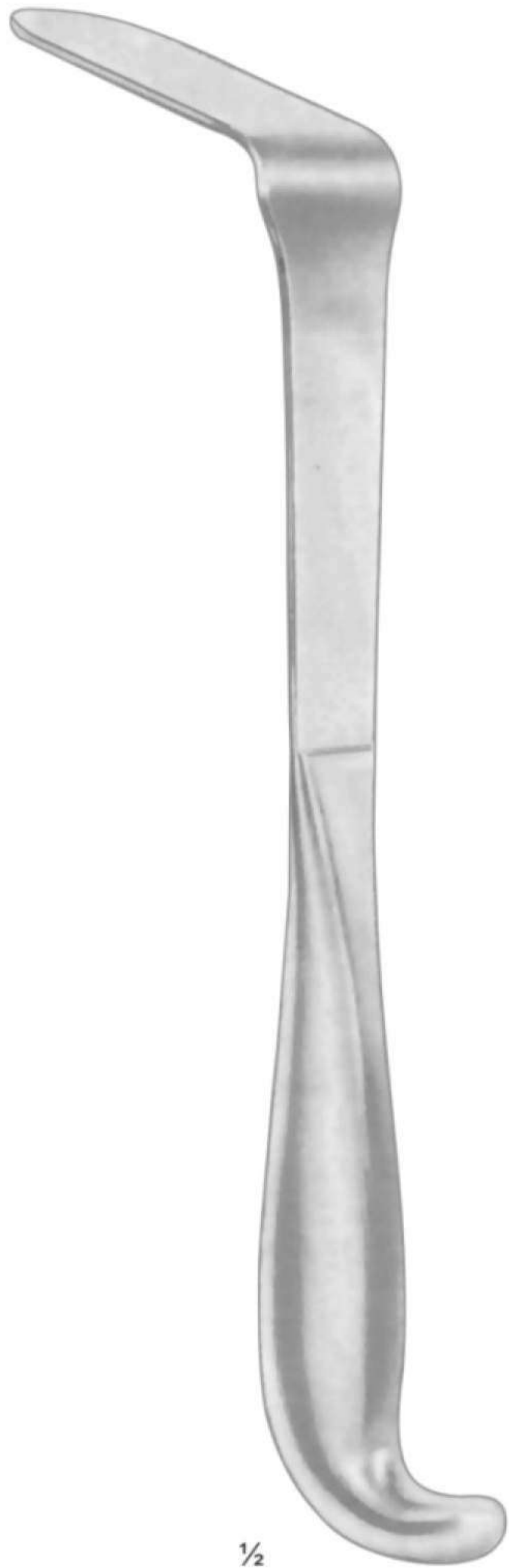

1/2

Doyen Vaginal Speculum
369-3106
24.0 cm / 9 1/2"

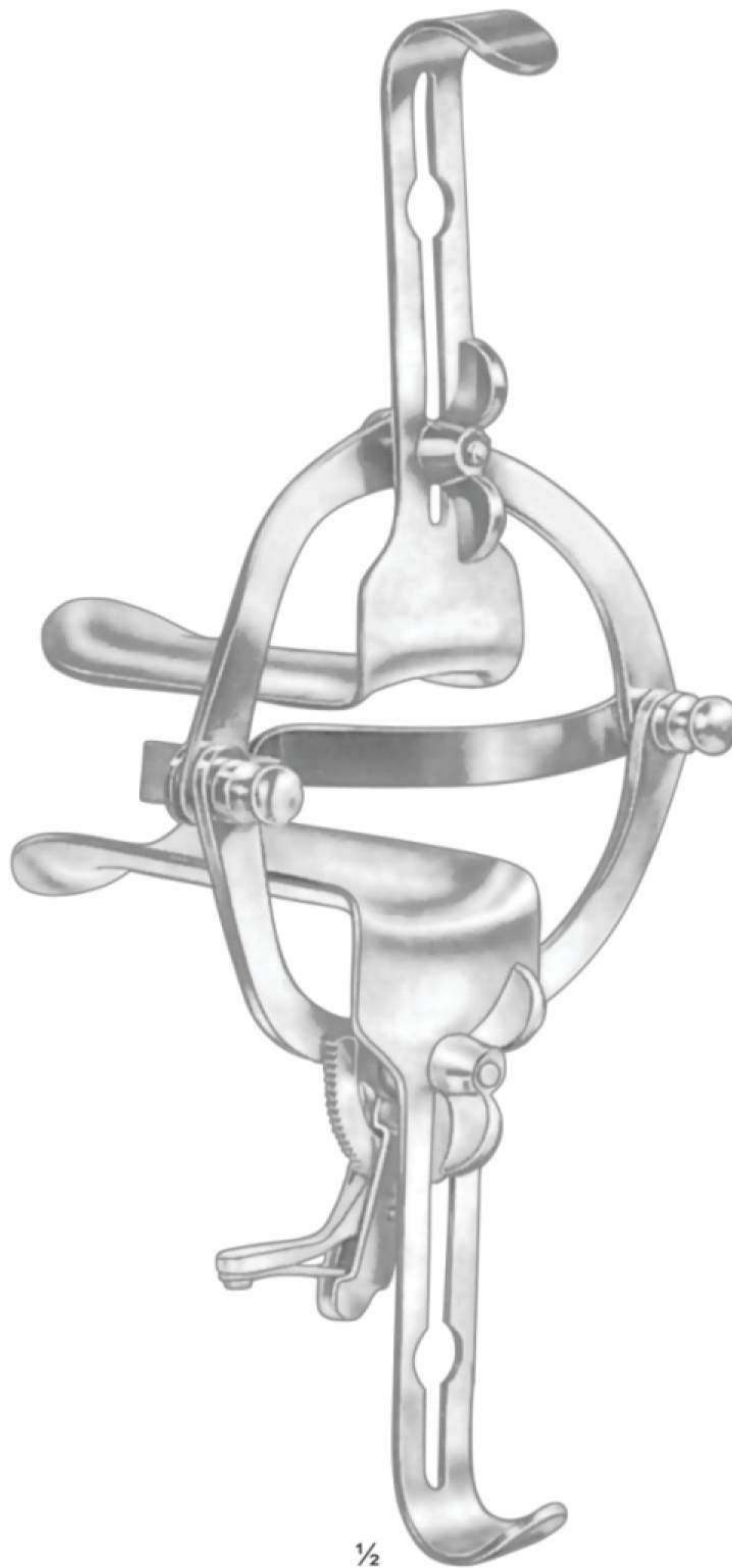

1/2

O'Sullivan-O'Connor
369-3107

Vaginal Speculum, for examination and operative work, self-retaining, with adjustable frame, Loktite ratchet, 2 mobile lateral blades and interchangeable blades fig. 1-3.

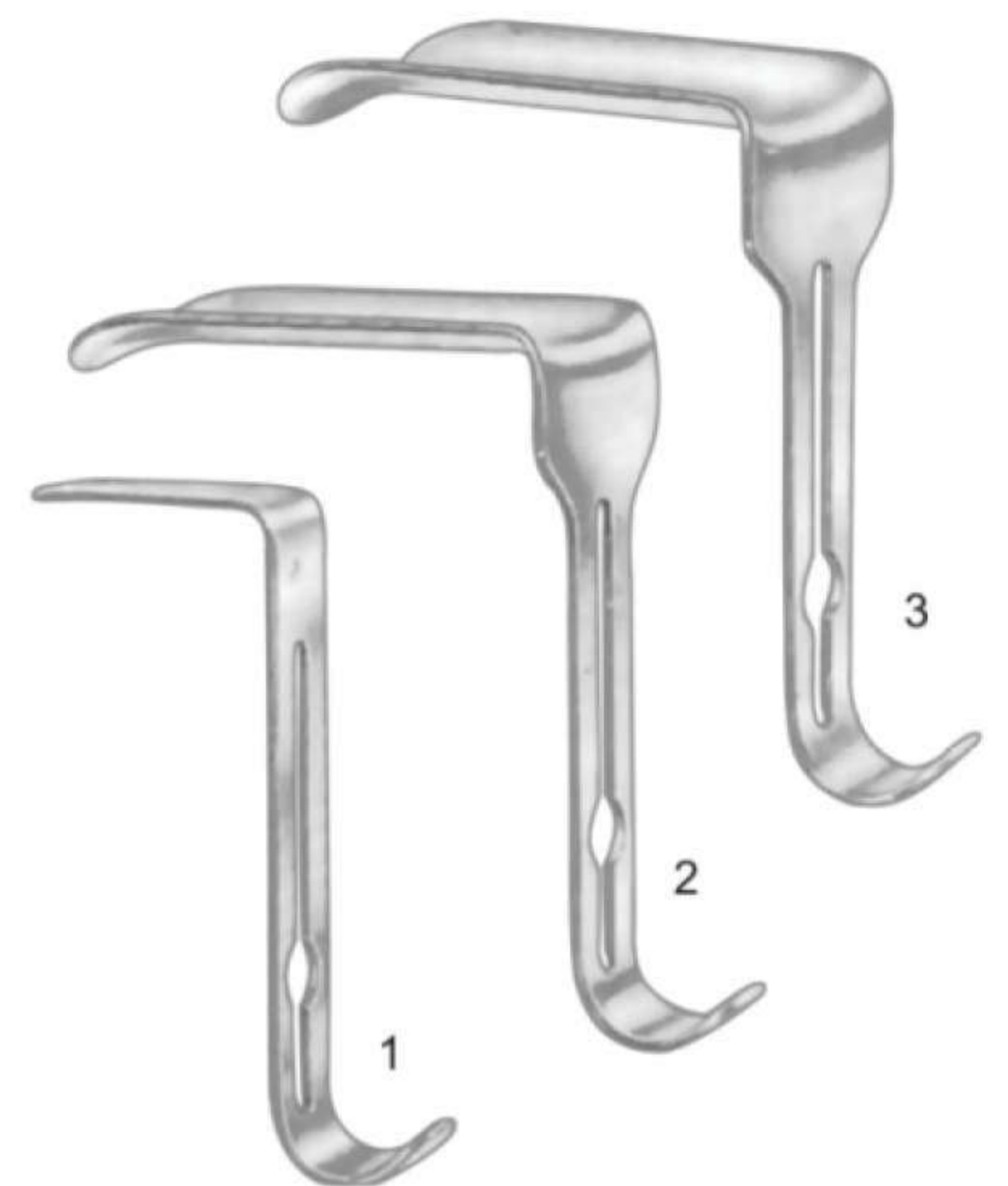
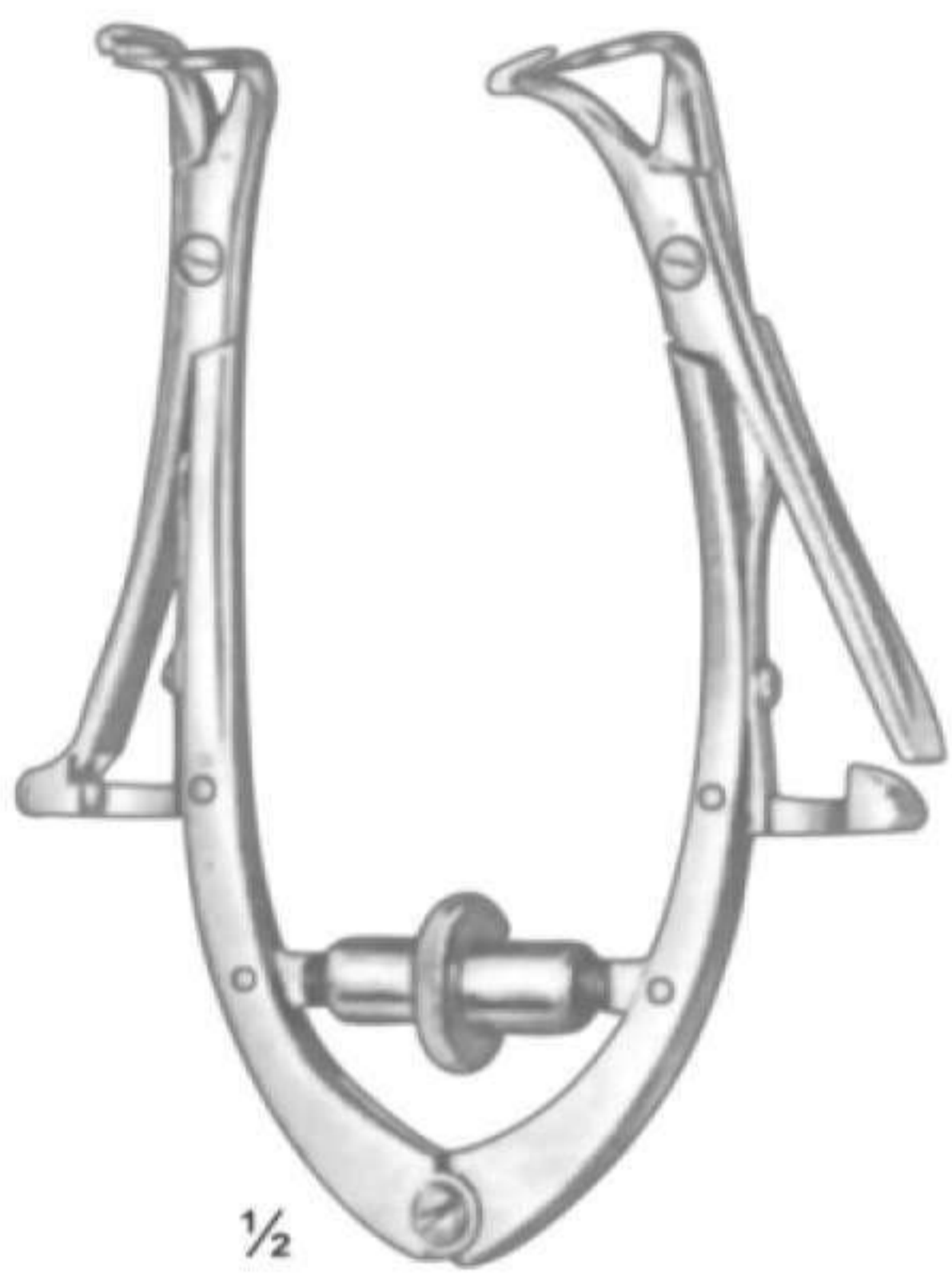

Fig. 1 = 45 x 17 mm
Fig. 2 = 90 x 37 mm
Fig. 3 = 90 x 45 mm

370

Retractors, Endospecula



1/2

Friedman
370-3108
10.0 cm / 4"

Retractor, self-retaining, for perineorrhaphy

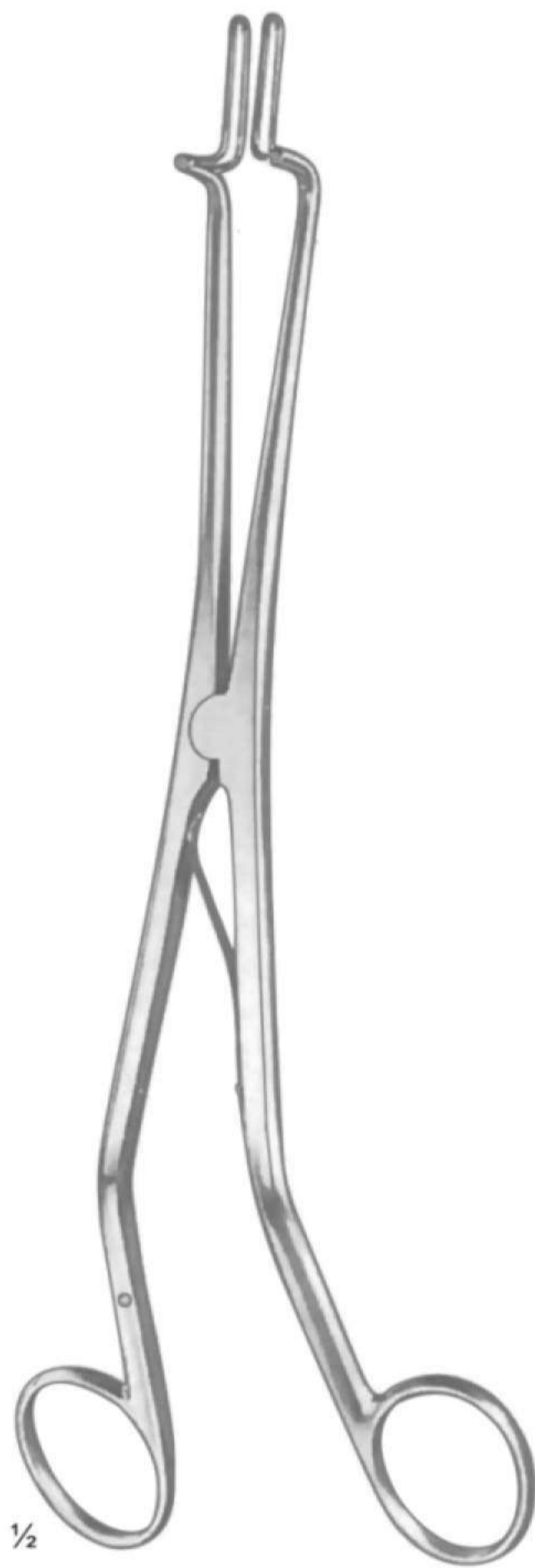

1/2

Kogan
370-3109
24.0 cm / 9 1/2"

without ratchet

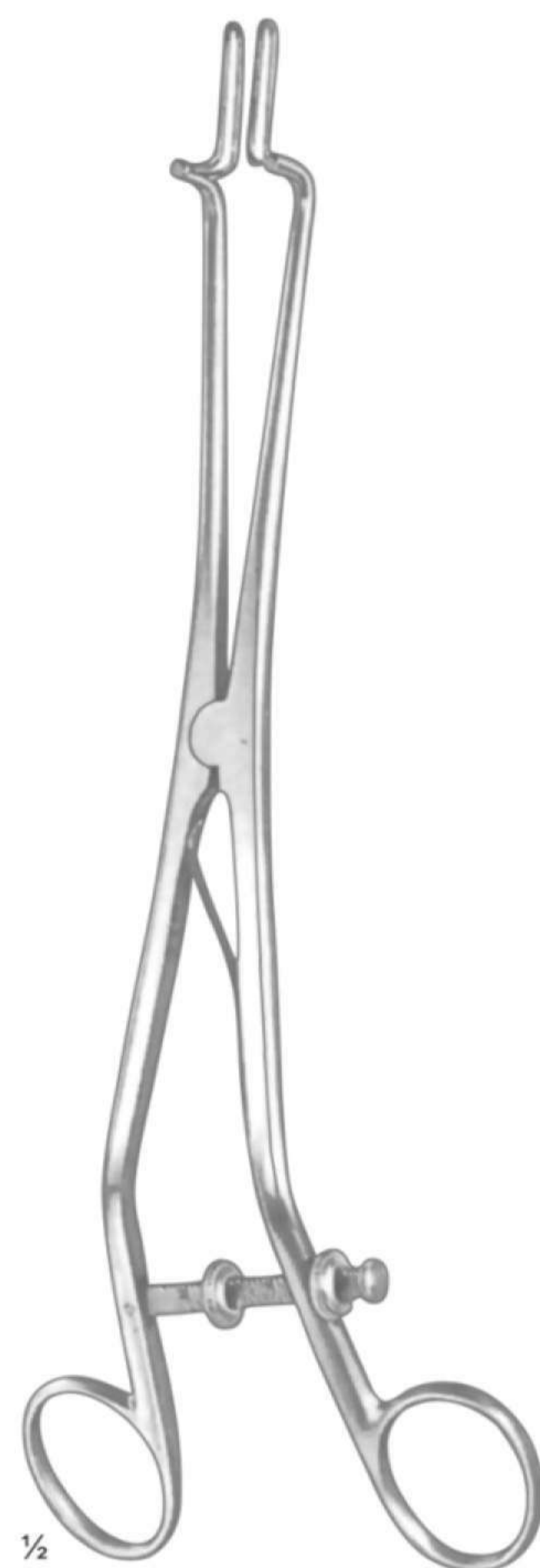

1/2

Kogan
370-3110
24.0 cm / 9 1/2"

with scale-ratchet and fixing screws

Uterine Dilators

371



1/2

Pieces per set

14	4.0-17.0	371-3111
26	1.0-26.0	371-3112

372

Uterine Dilators



372-3113
set of 14 dilators
(4.0-17.0 mm \emptyset), in metal case with hinged lid

372-3114
set of 26 dilators
(1.0-26.0 mm \emptyset), in metal case with hinged lid



1/2

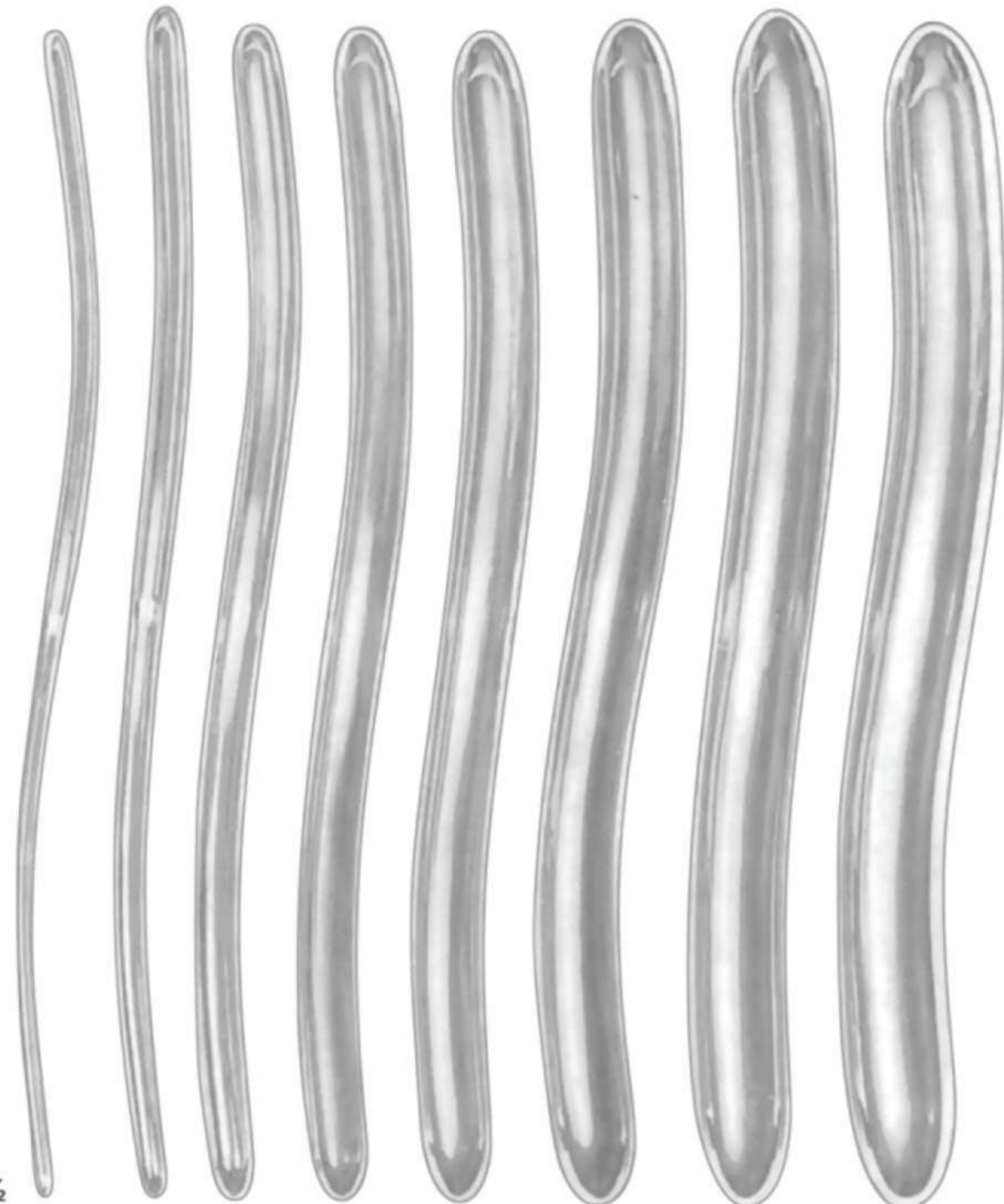

1/2

372-3115
set of 8 Dilator
(3.0/4.0 - 17.0/18.0 mm \emptyset)

372-3116
set of 13 Dilator
(1.0-2.0-25.0/26.0 mm \emptyset)

Uterine Dilators

373



373-3117
 set of 8 dilators
 (3.0/4.0-17.0/18.0 mm \varnothing ,
 in boilable canvas roll

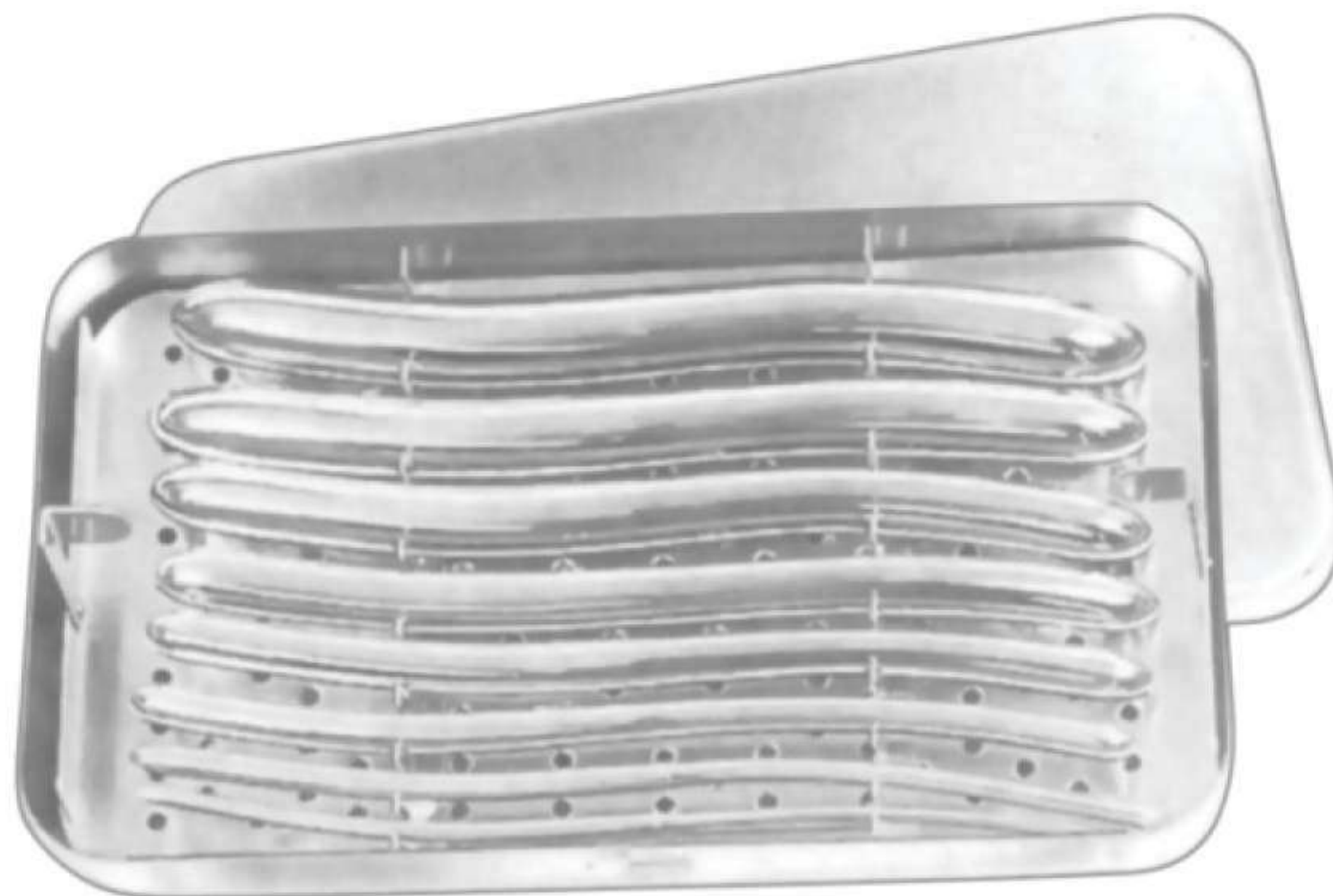

373-3118
 set of 8 dilators
 (3.0/4.0-17.0/18.0 mm \varnothing ,
 in metal case with hinged lid



373-3119
 set of 13 dilators
 (1.0/2.0-25.0/26.0 mm \varnothing ,
 in metal case with hinged lid

374

Uterine Sounds, Depressors & Tenaculum Forceps

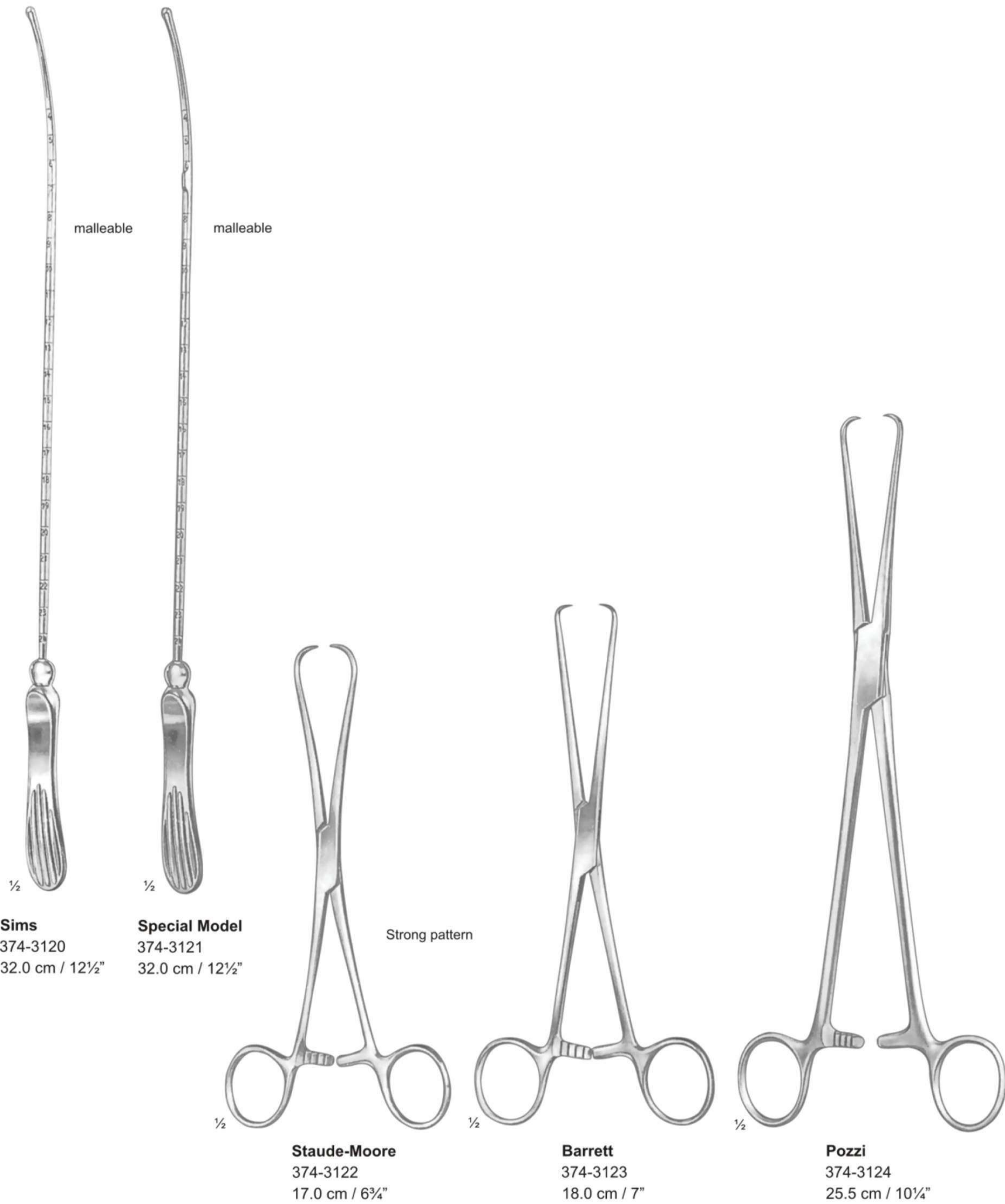

Tenaculum Forceps

375



1/2

Schroeder
375-3125
25.0 cm / 10"



1/2

Braun
375-3126
25.0 cm / 10"

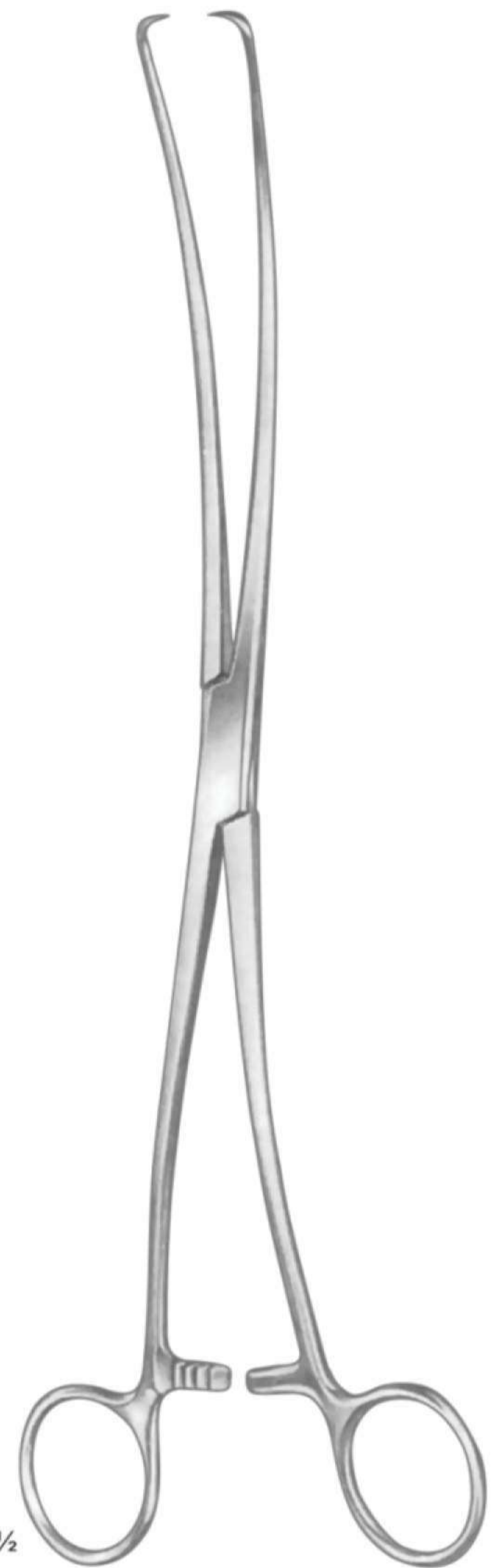

1/2

Duplay
375-3127
28.0 cm / 11"

376

Tenaculum Forceps

Amniotome for the amnion bladder



1/2

Beacham
376-3128
26.0 cm / 10 1/4"



1/2

Skene
376-3129
24.0 cm / 9 1/4"

Tenaculum Forceps

377

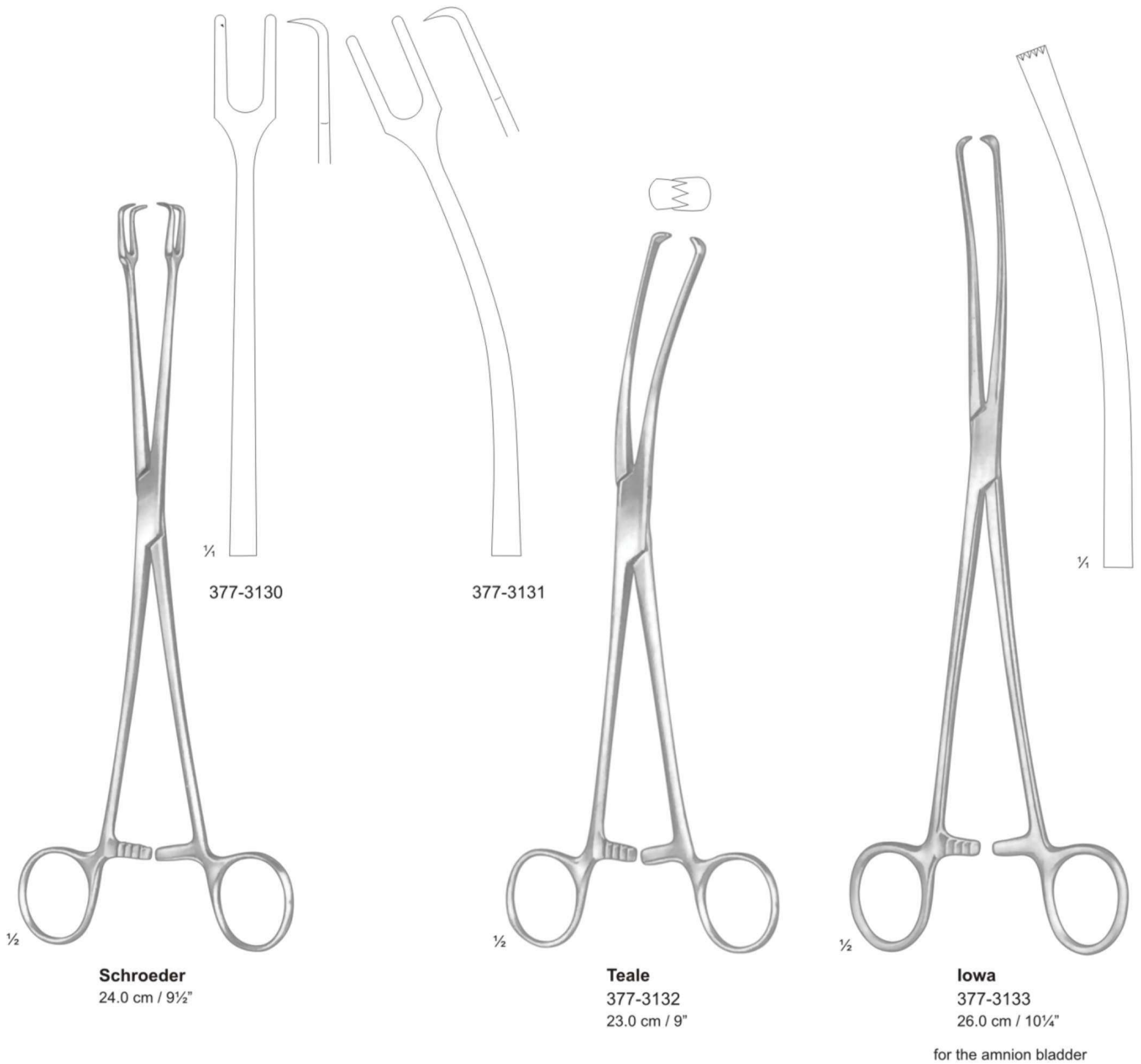

378

Tenaculum Forceps



Museux
24.0 cm / 9½"

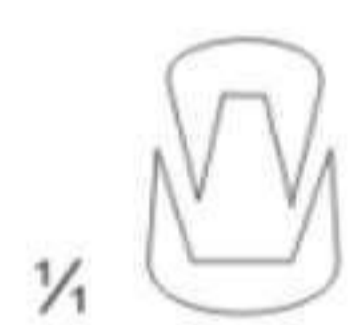

6 mm

378-3134



8 mm

378-3135



10 mm

378-3136



Museux
24.0 cm / 9½"

curved sideways



6 mm

378-3137



8 mm

378-3138

Tenaculum Forceps

379

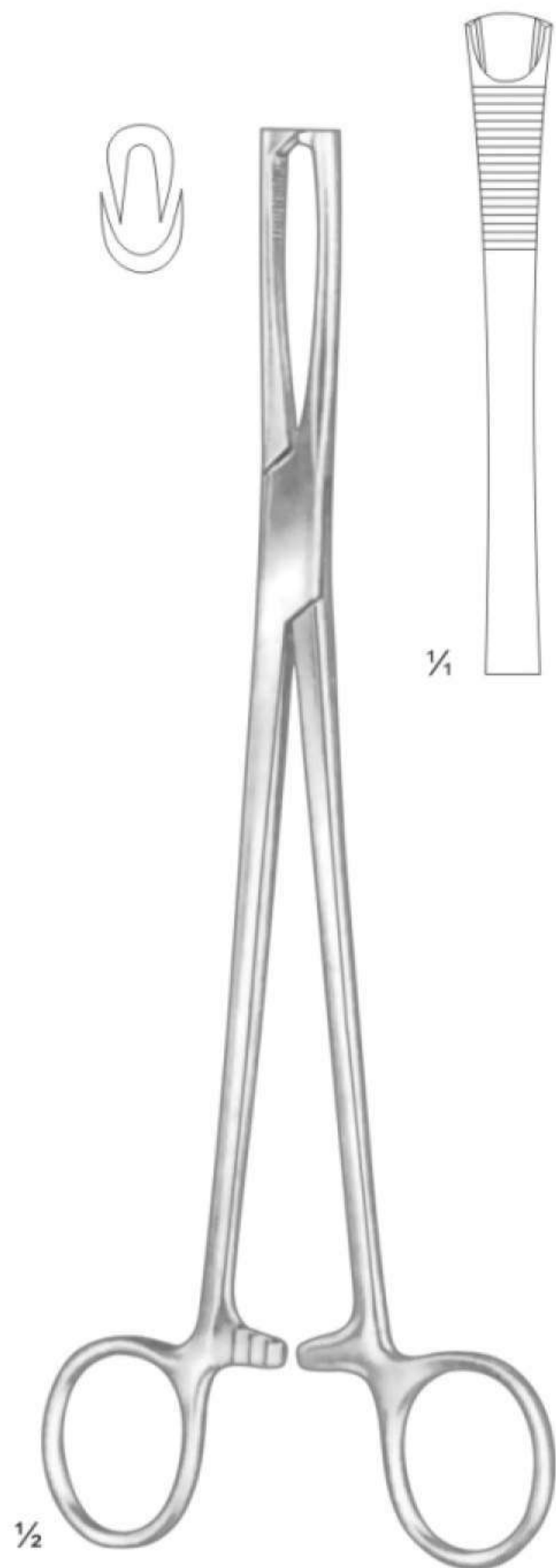

Jacobs
379-3139
21.0 cm / 8¼"



Henrotin
379-3140
20.5 cm / 8"

380

Tenaculum Forceps

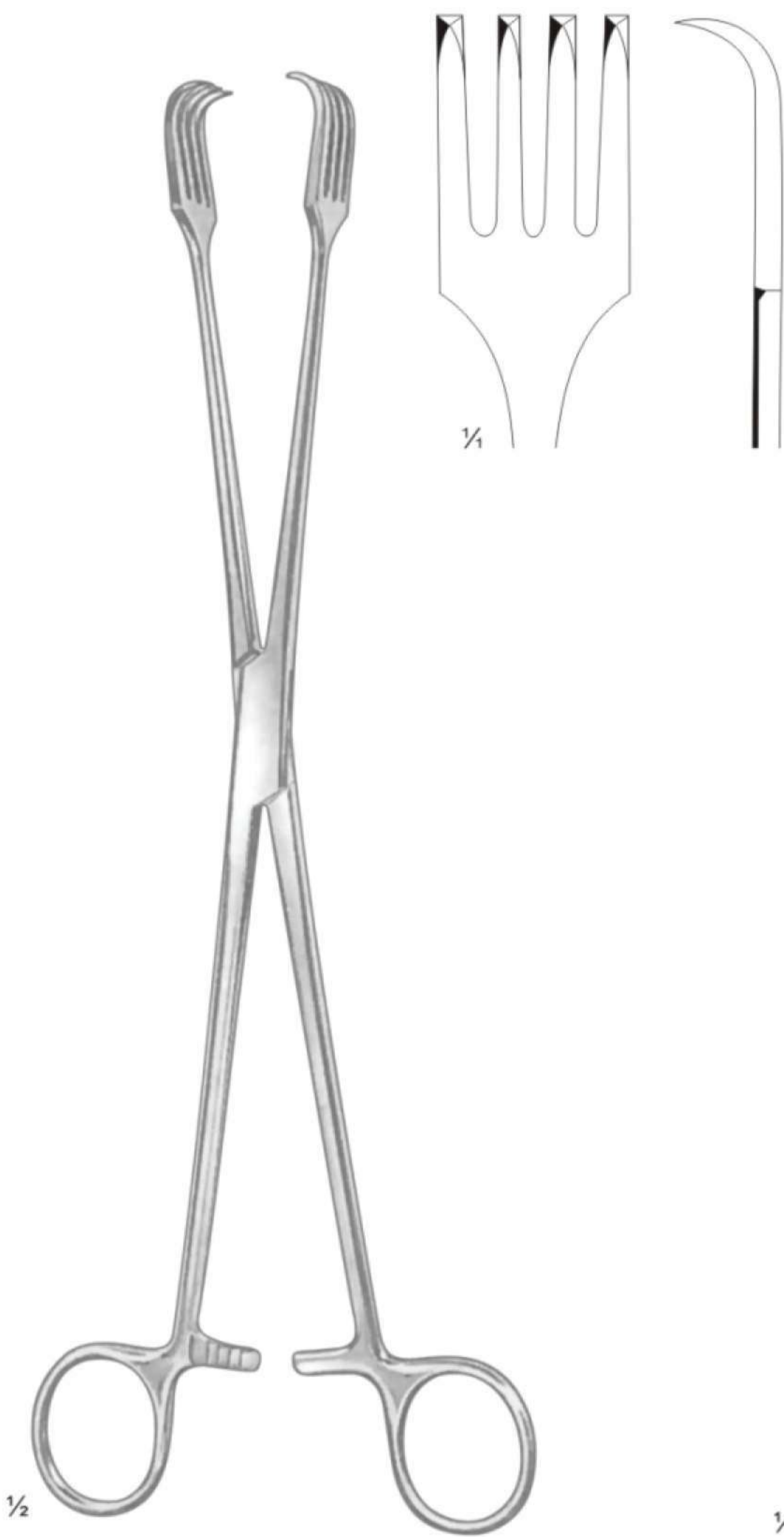

380-3141
26.0 cm / 10 $\frac{1}{4}$ "

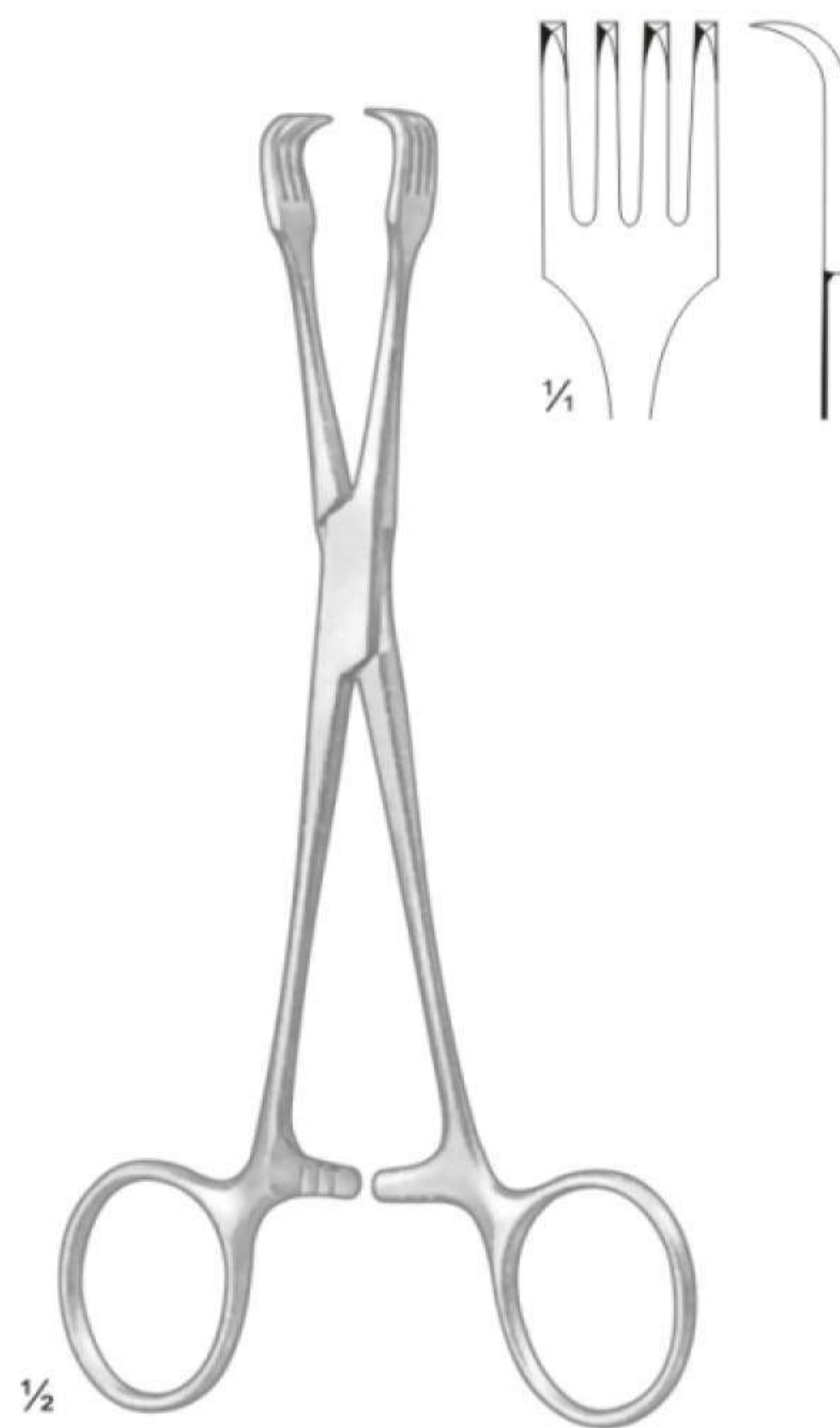

Braun
380-3142
16.0 cm / 6 $\frac{1}{4}$ "

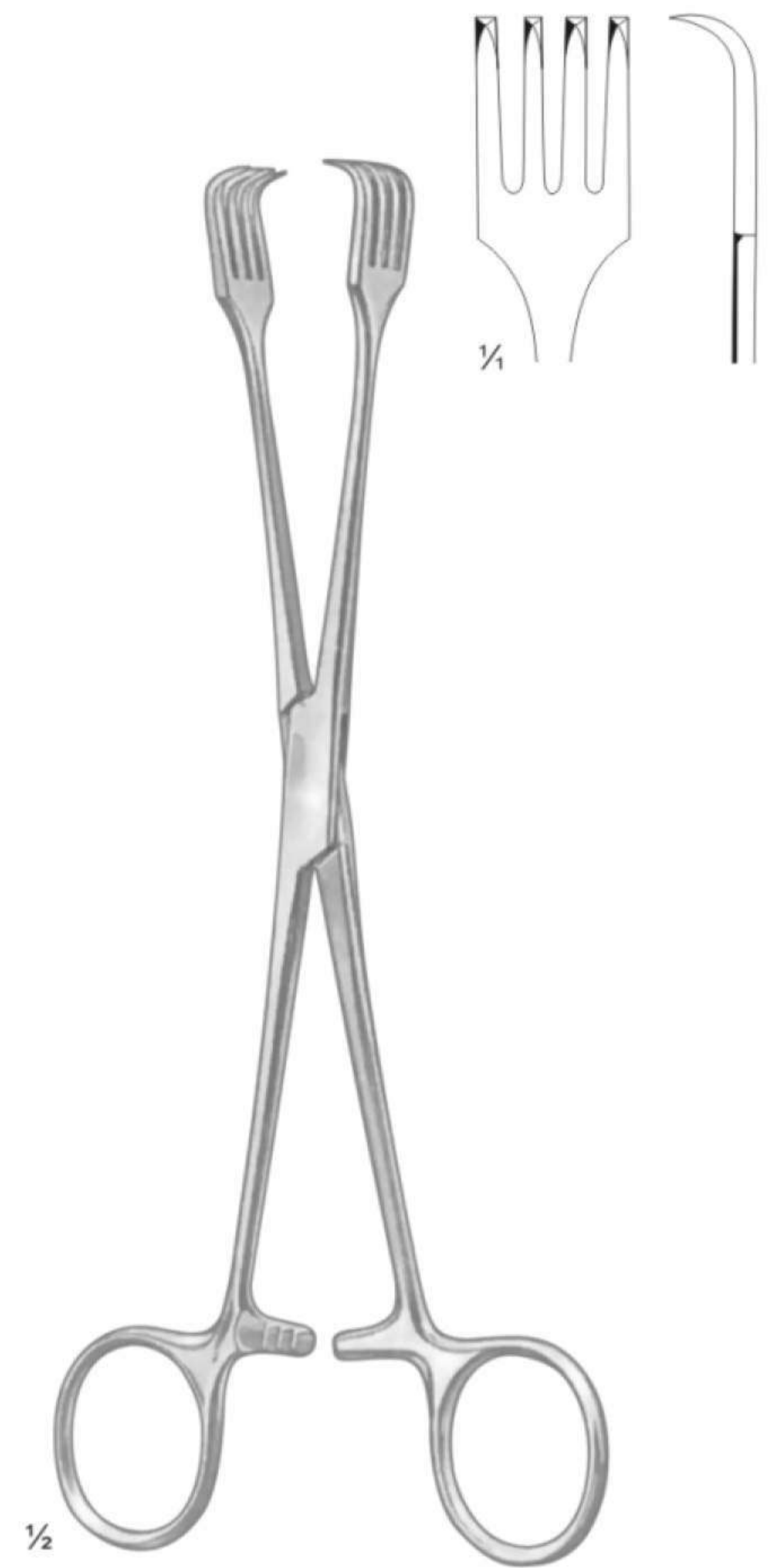

Czerny
380-3143
21.0 cm / 8 $\frac{1}{4}$ "

382

Myoma Instruments



Doyen
382-3147
17.0 cm / 6 $\frac{3}{4}$ "



Doyen
382-3148
17.0 cm / 6 $\frac{3}{4}$ "

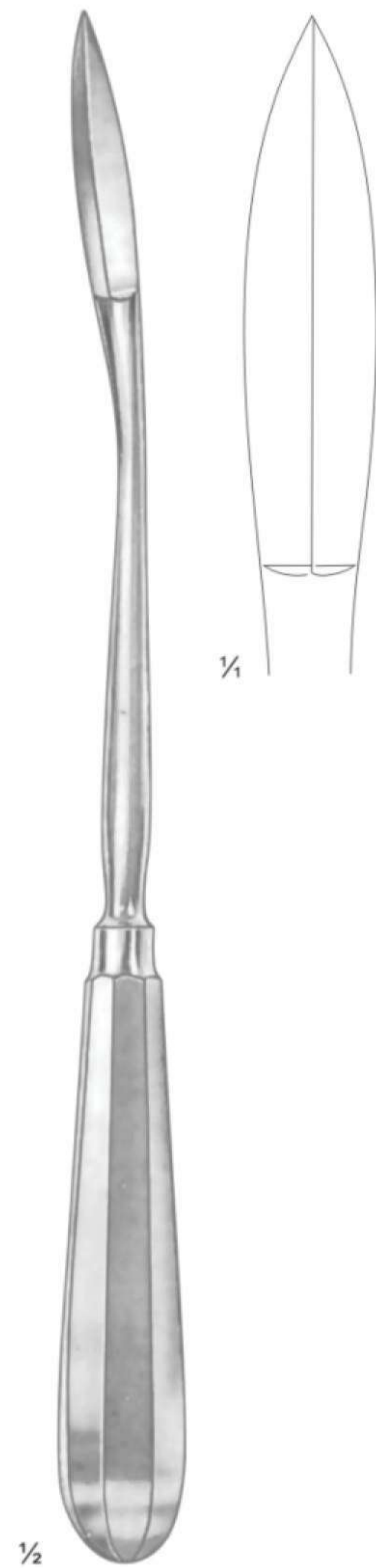

Segond
382-3149

Uterine Elevating Forceps

383

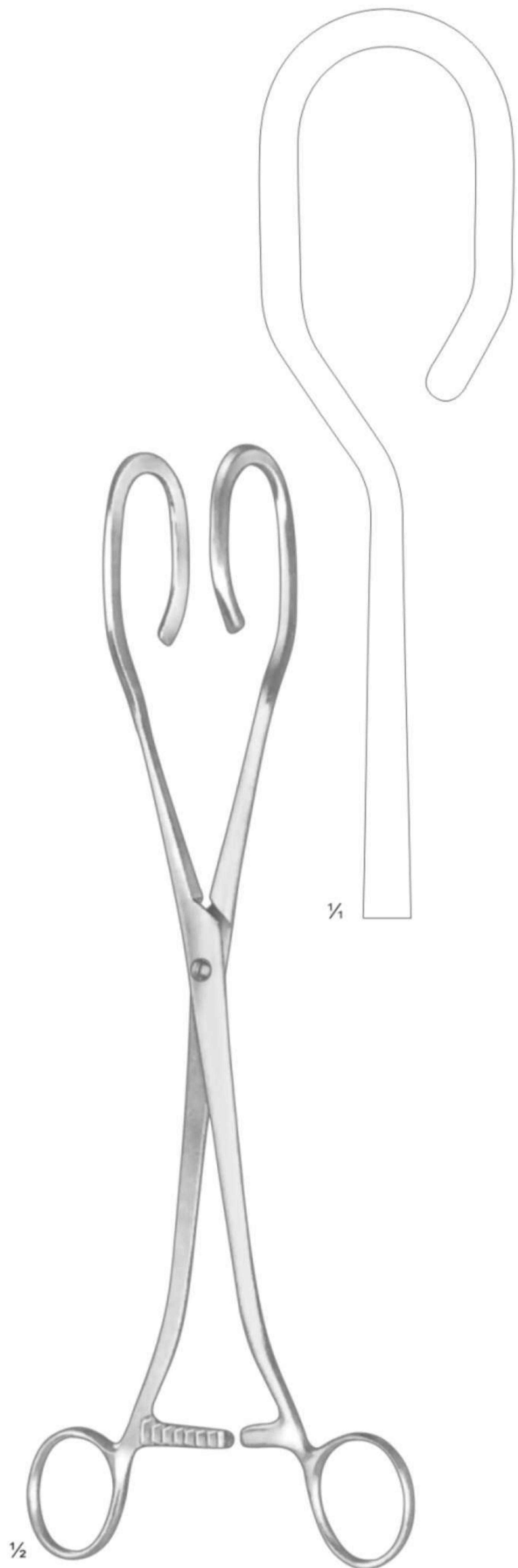

Dartingues
383-3150
27.0 cm / 10½"

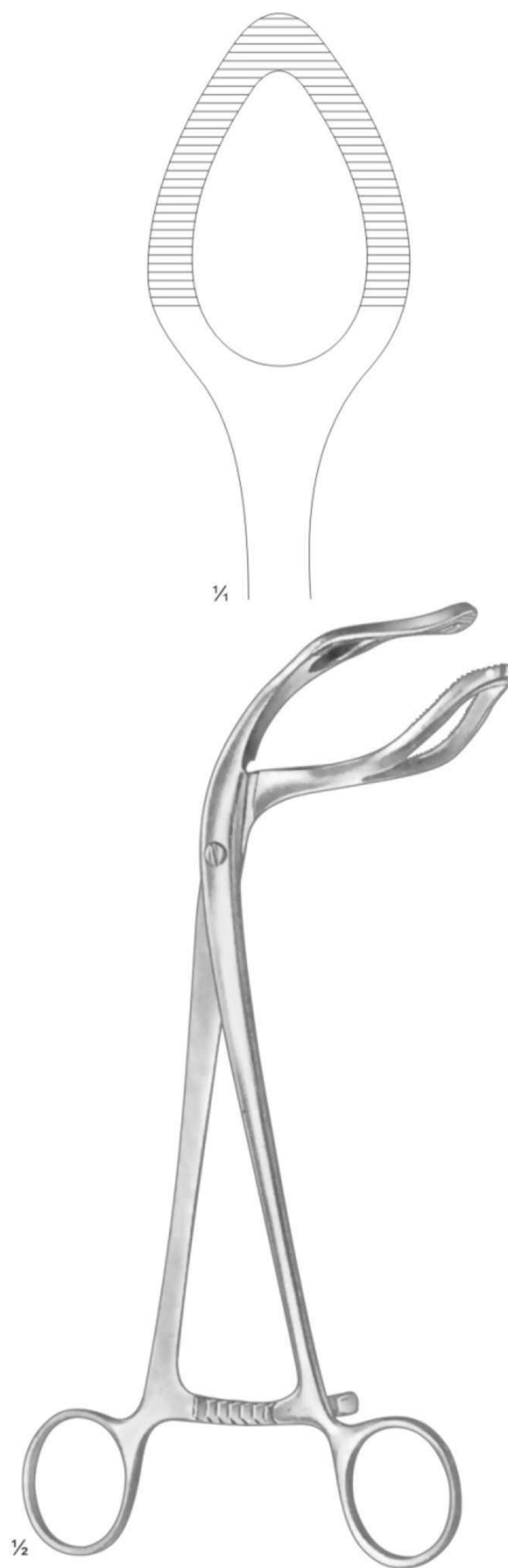

Somer
383-3151
23.0 cm / 9"



Collin
383-3152
25.0 cm / 10"

384

Suction Biopsy Curettes

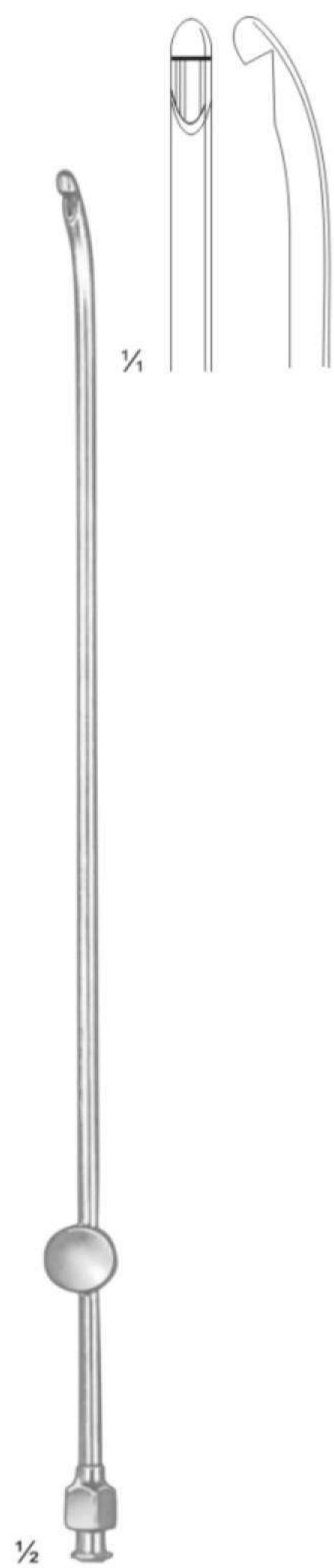

Randall
384-3153
24.0 cm / 9½"
4 mm ø



Novak
384-3154
23.0 cm / 9"
4 mm ø



Kevorkian
384-3155
30.0 cm / 12"



Mod. Muenchen
384-3156
27.0 cm / 10½"

Biopsy Curettes

Endometrial Suction Biopsy Curettes

Cervical Biopsy and Specimen Forceps

385

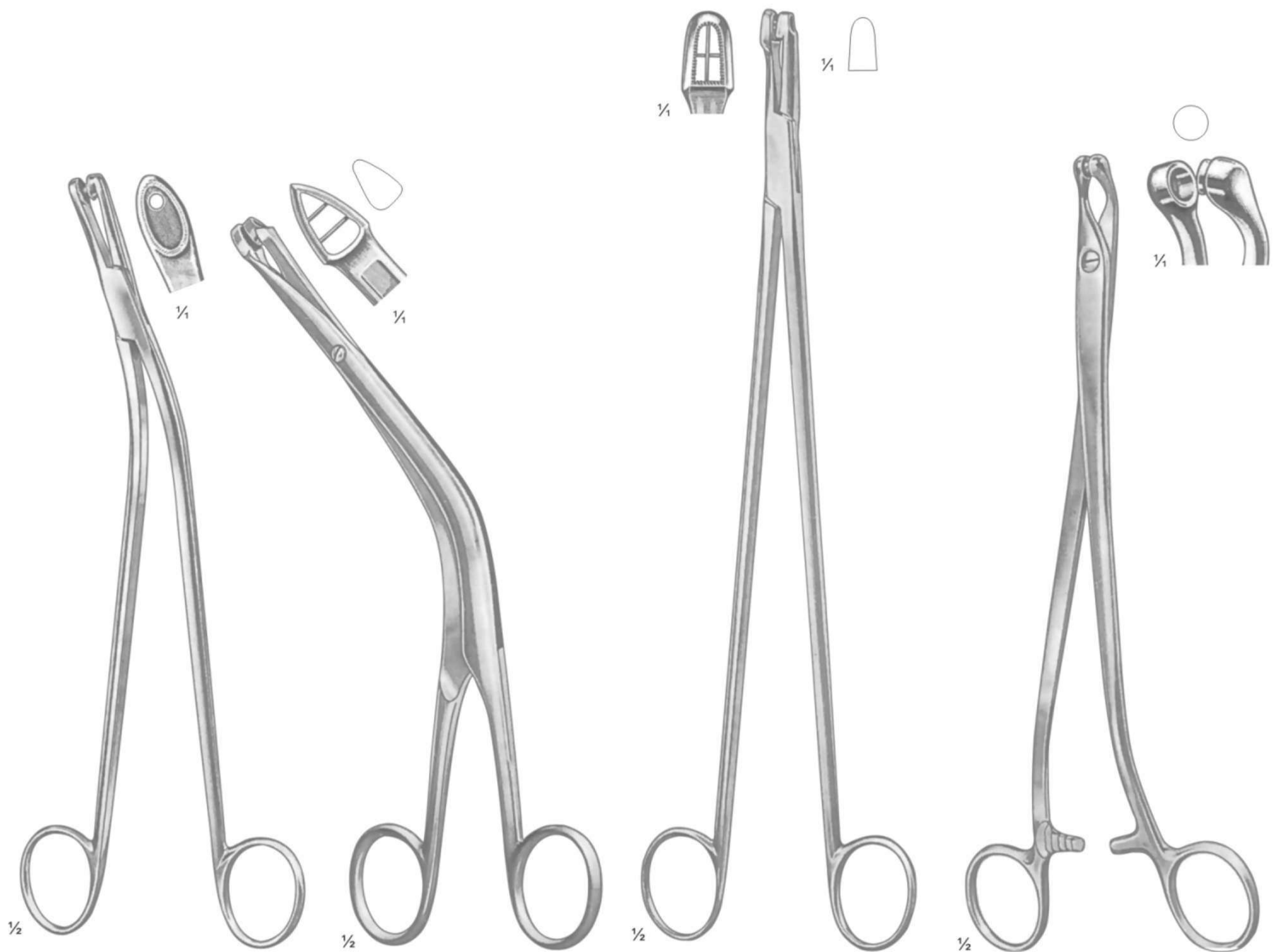

Gellhorn
385-3157
23.0 cm / 9"

Faure
385-3158
21.0 cm / 8 1/4"

Schubert
385-3159 - 21.0 cm / 8 1/4"
385-3160 - 29.0 cm / 11 1/2"

Thoms-Gaylor
385-3161
24.0 cm / 9 1/2"

386

Cervical Biopsy and Specimen Forceps

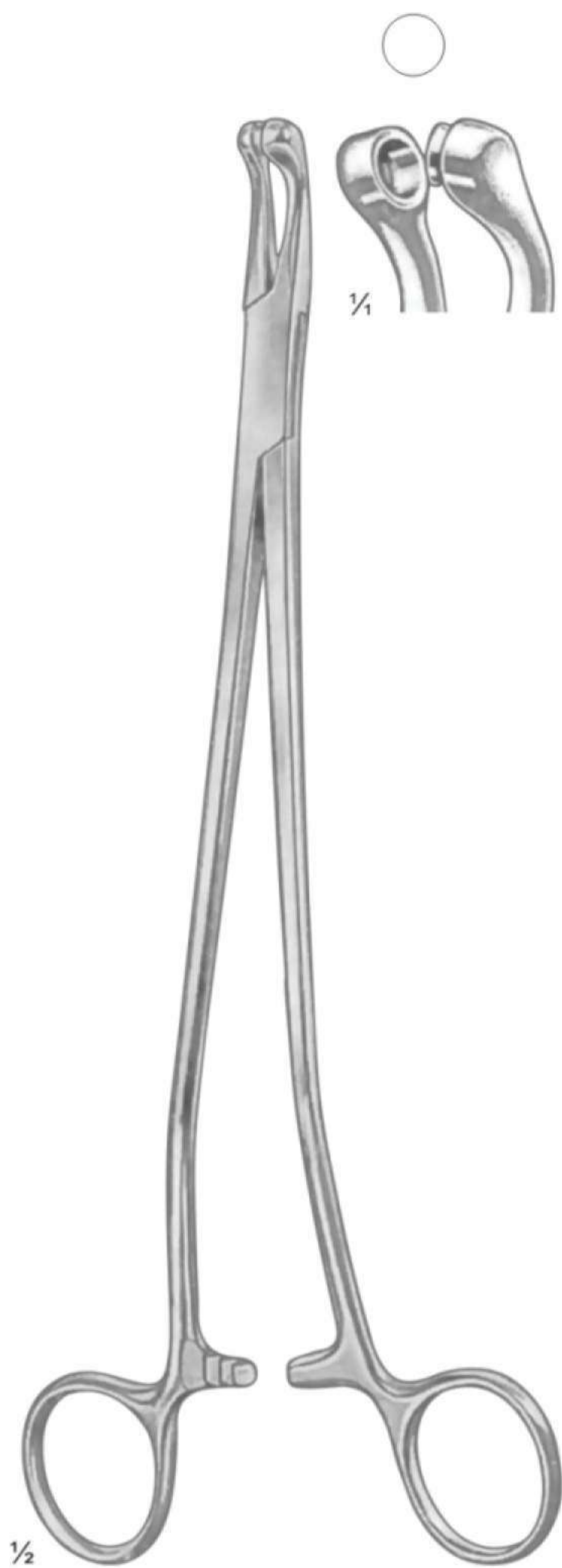

Thoms-Gaylor
386-3162 - 22.0 cm / 8½"
386-3163 - 24.0 cm / 9½"

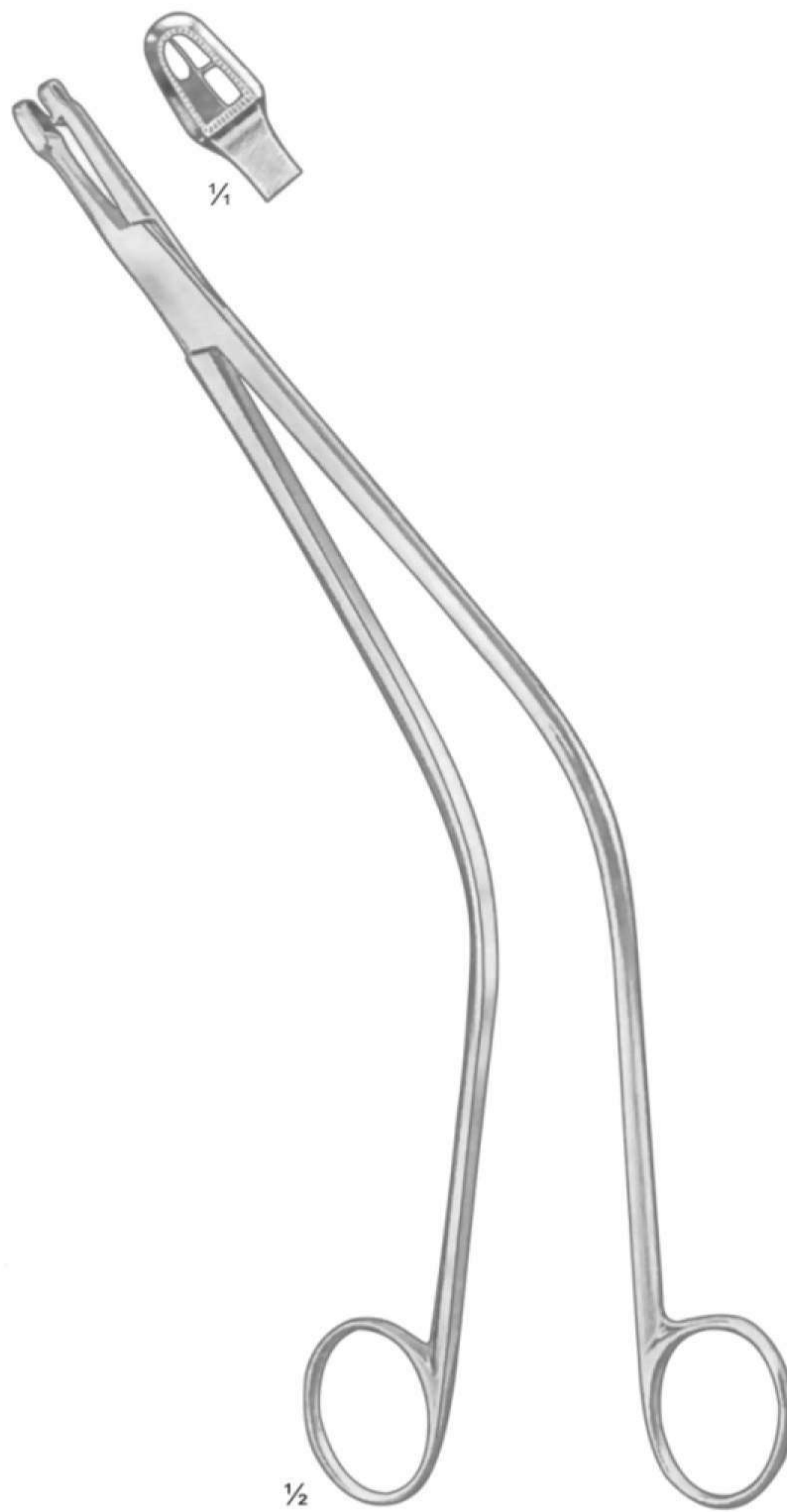

Schubert
386-3164
26.0 cm / 10¼"

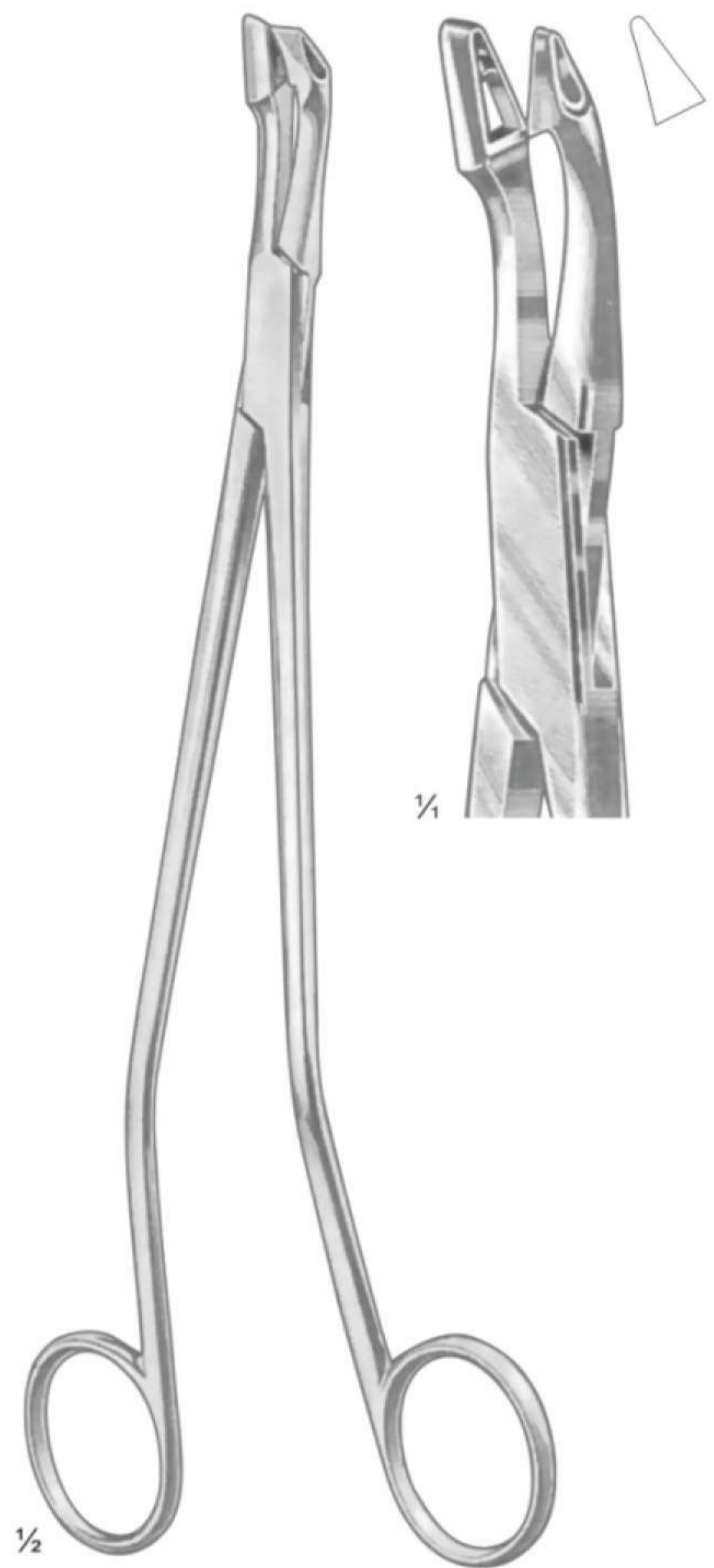

Van Doren
386-3165
24.0 cm / 9½"

Cervical Biopsy and Specimen Forceps

387

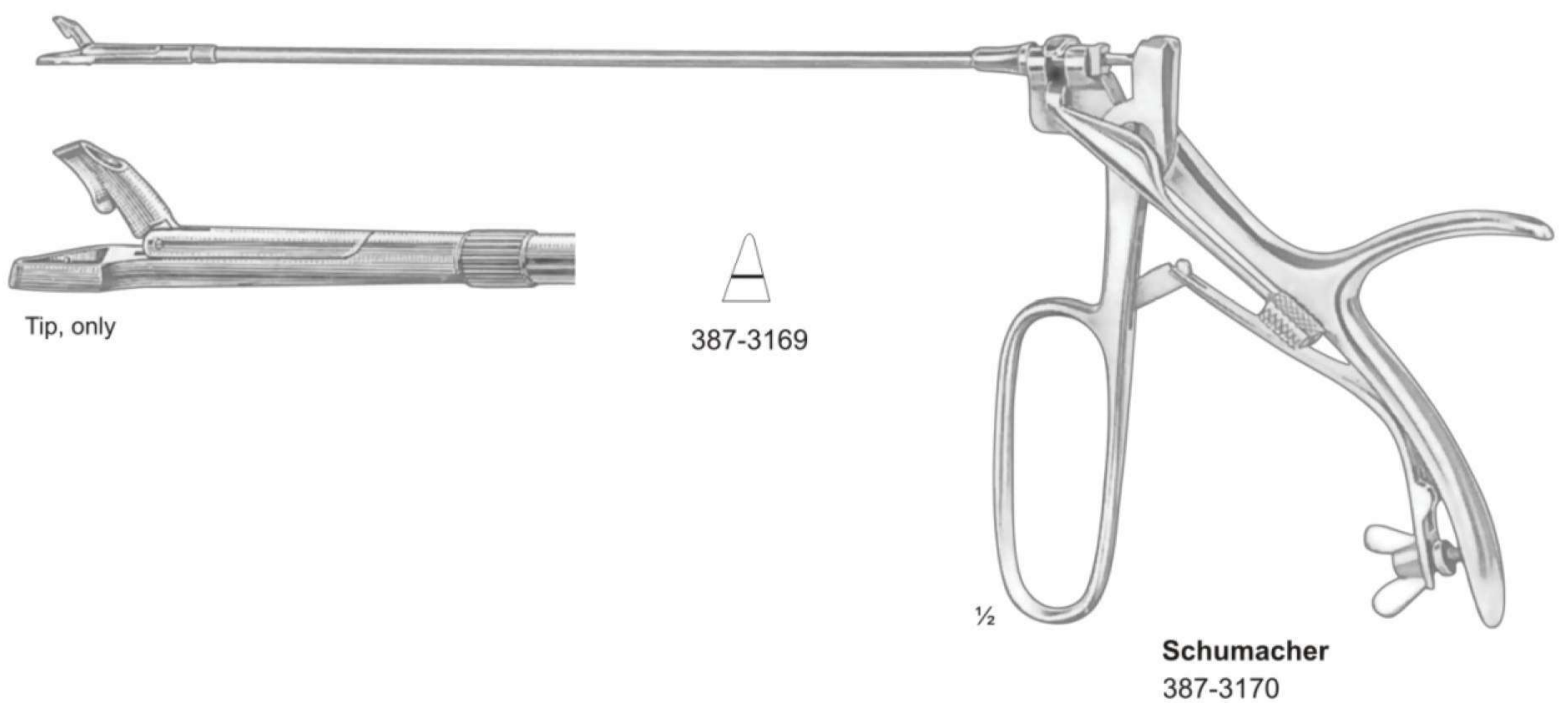
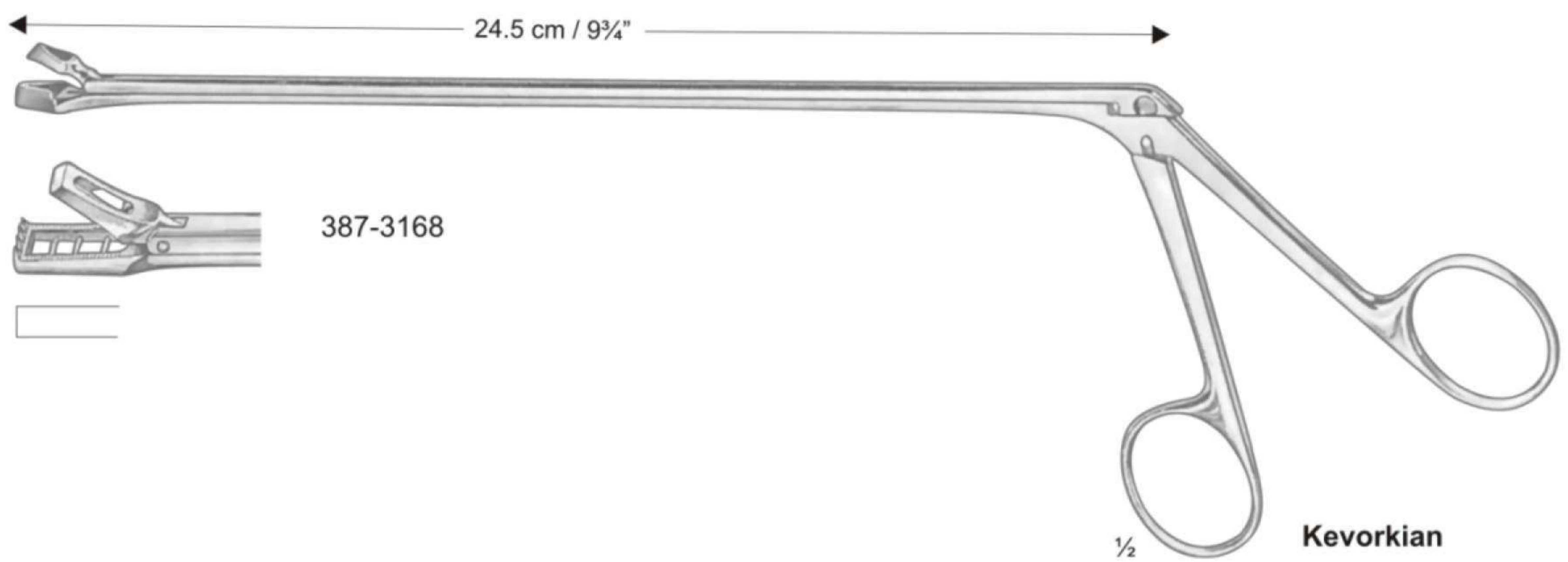
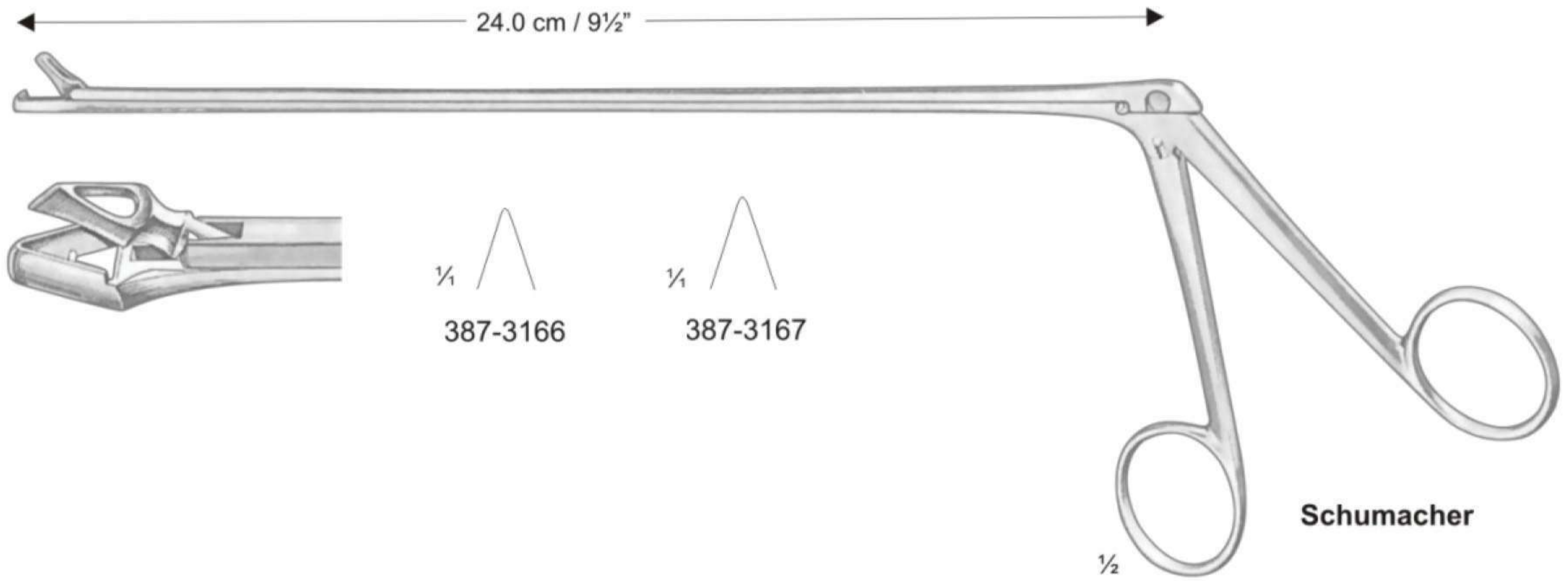

388

Uterine Scoops



388-3171

388-3172

388-3173

388-3174

388-3175

$\frac{1}{4}$ 388-3176

$\frac{1}{2}$

Simon
25.0 cm / 10"
sharp, rigid



388-3177

388-3178

388-3179

388-3180

388-3181

$\frac{1}{4}$ 388-3182

$\frac{1}{2}$

Schroeder
30.0 cm / 12"
sharp, rigid

Uterine Curettes

389

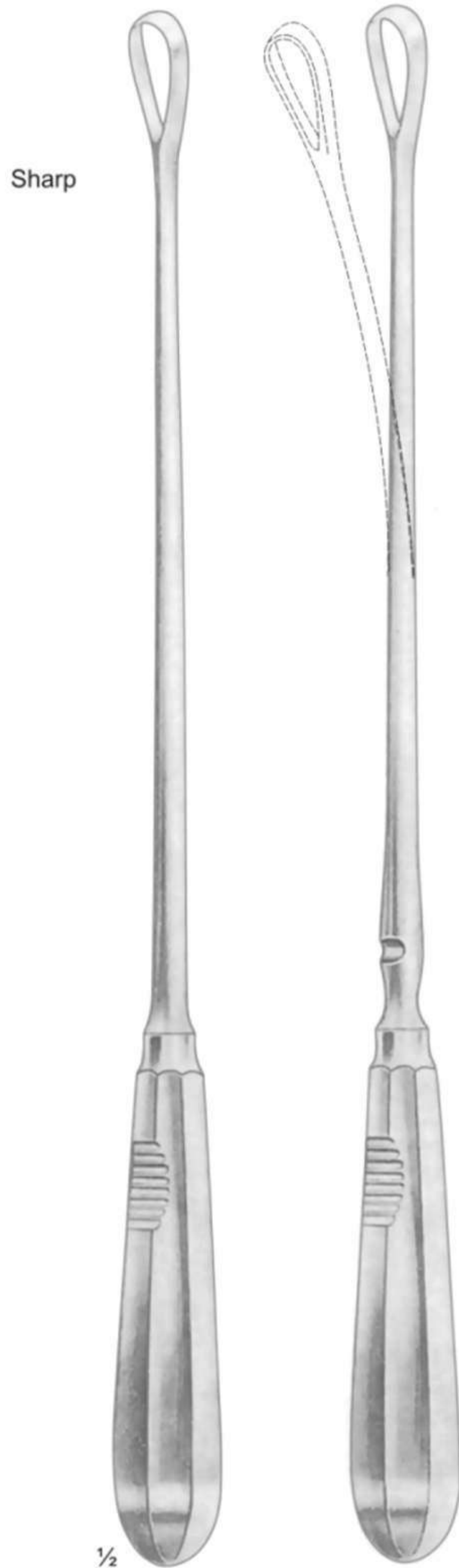

Recamier-Sims-Bumm
389-3183
31.0 cm / 12½"
Fig. 00-16
rigid

Recamier-Sims-Bumm
389-3184
31.0 cm / 12½"
Fig. 00-16
malleable



Recamier-Sims-Bumm
389-3185
31.0 cm / 12½"
Fig. 00-16
rigid

Recamier-Sims-Bumm
389-3186
31.0 cm / 12½"
Fig. 00-16
rigid



Sharp Curettes
(Recamier Handle)



Malleable Curettes
(grooved shaft)



Rigid Curettes
(plain shaft)



Blunt Curettes
(Sims Handle)

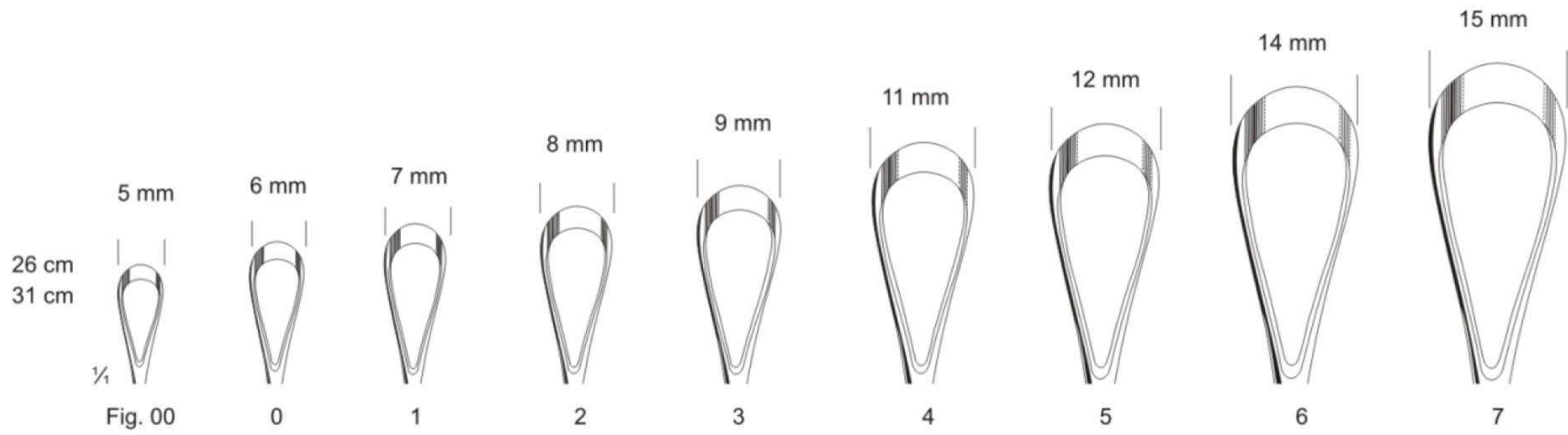

Last two digits

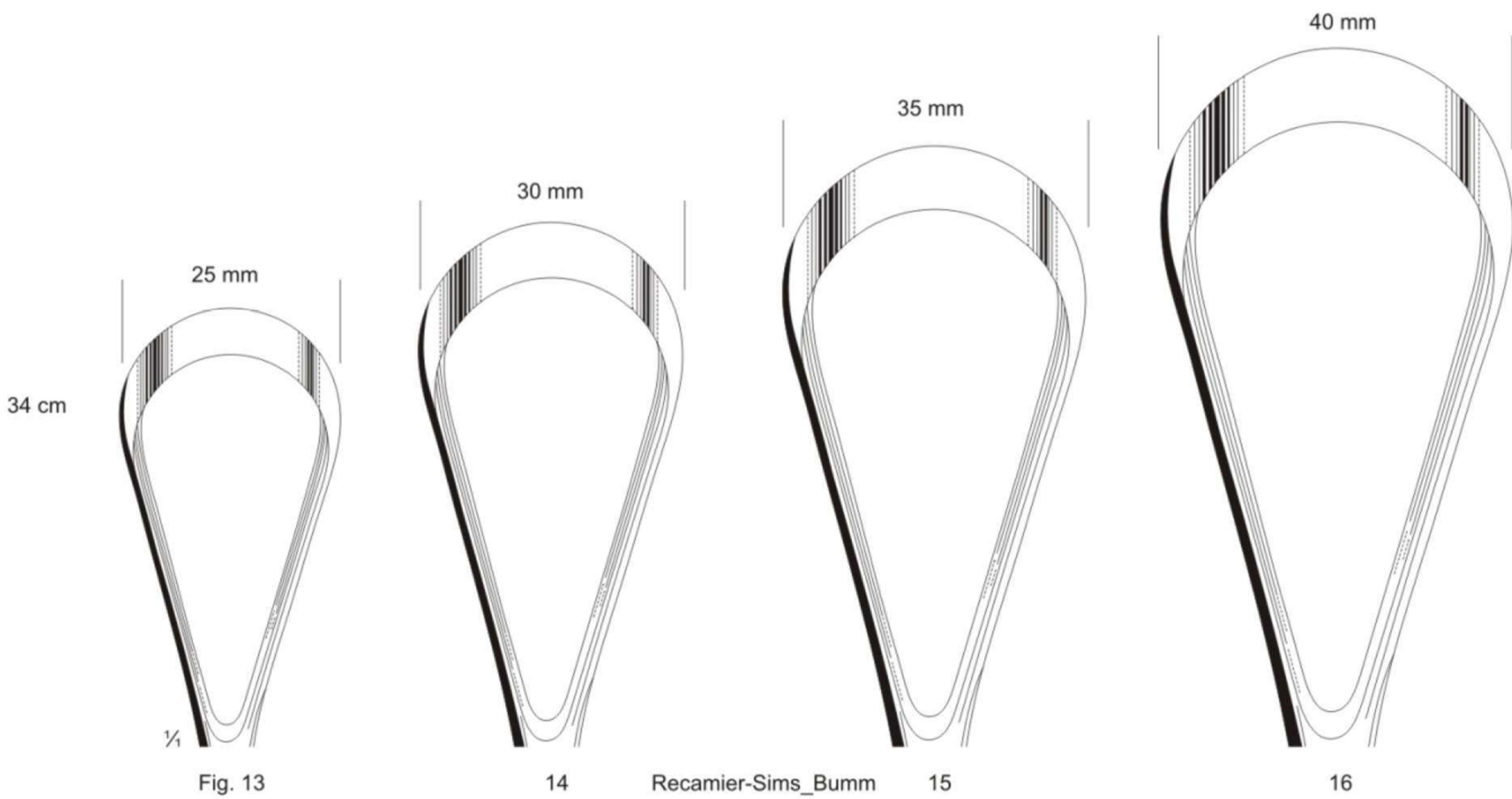
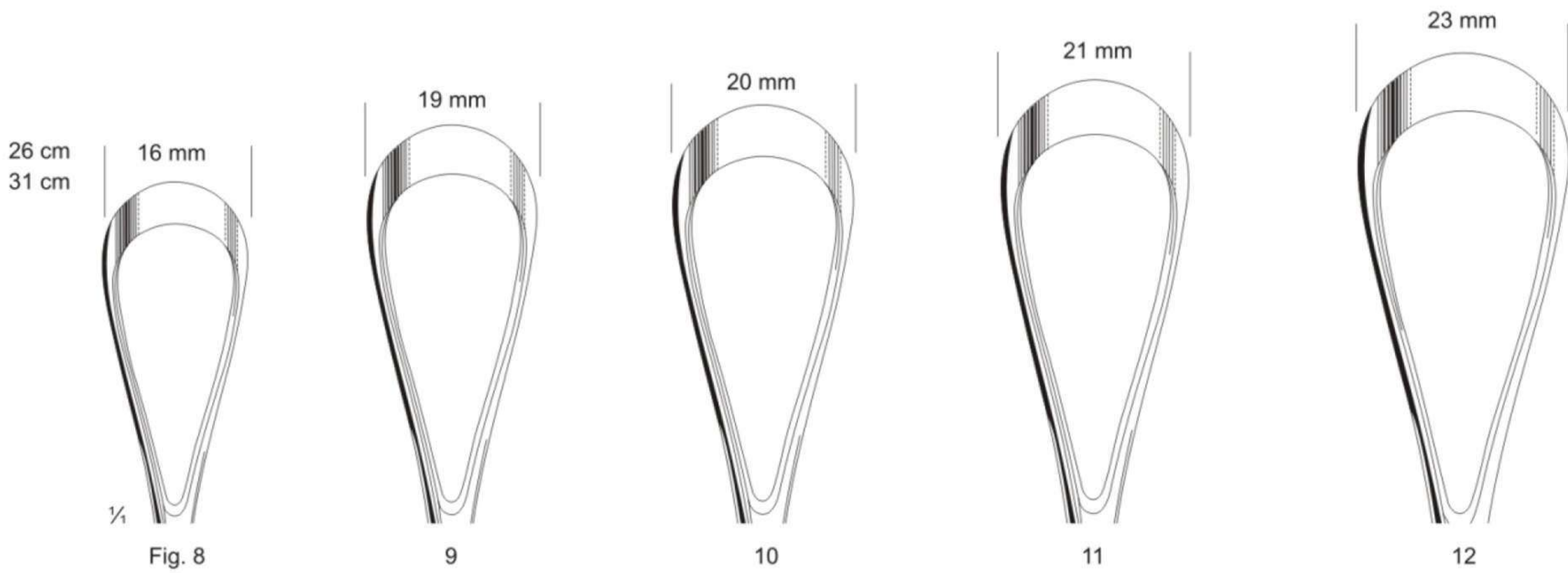

Recamier-Sims_Bumm

Pelvimeters and Obstetrical Forceps



Special Model
391-3187
34.0 cm / 13½"
cm/inch scale



Collin
391-3188
35.0 cm / 13¾"
cm scale



Breisky
391-3189
33.0 cm / 13"
cm/inch scale

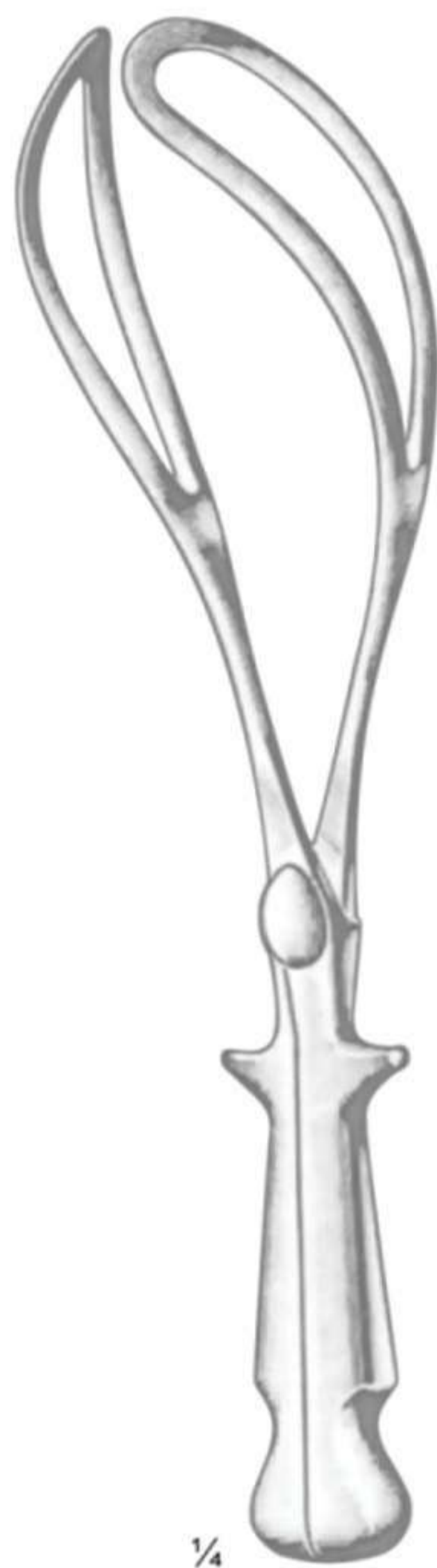

Naegele
391-3190 - 36.0 cm / 14"
391-3191 - 40.0 cm / 16"



Simpson
391-3192
30.0 cm / 12"

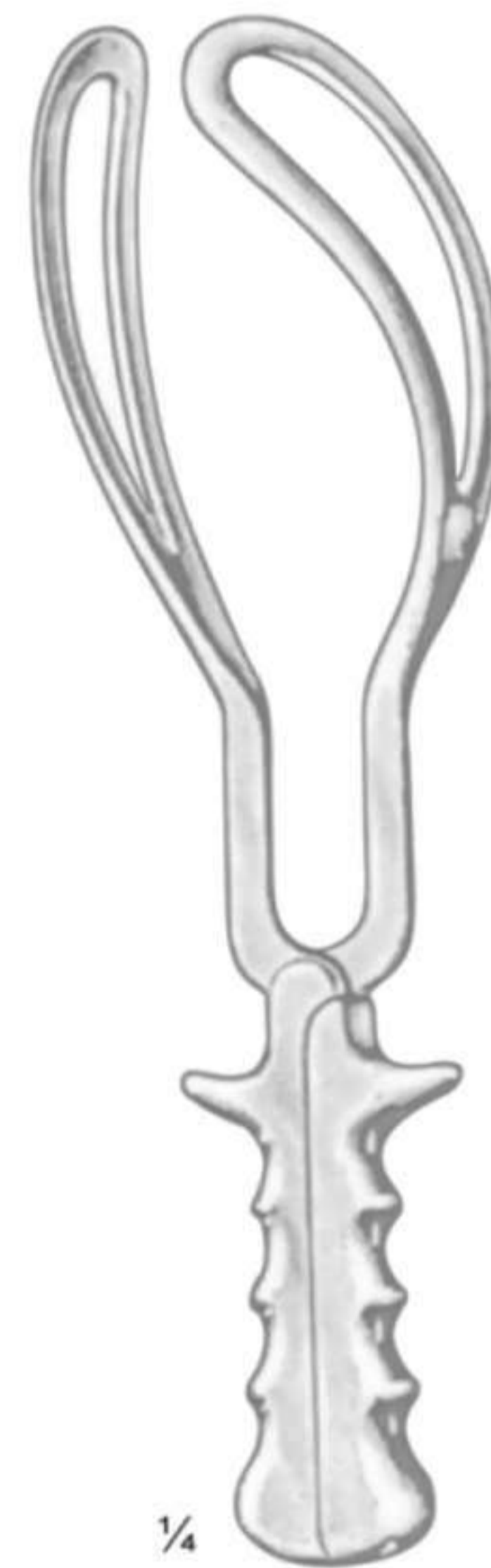

Simpson-Braun
391-3193
36.0 cm / 14"



Simpson-Luikart
391-3194
36.0 cm / 14"

392

Obstetrical Forceps



De Lee
392-3195
36.0 cm / 12"



De Lee
392-3196-36.0 cm / 14"
392-3197-39.0 cm / 15½"

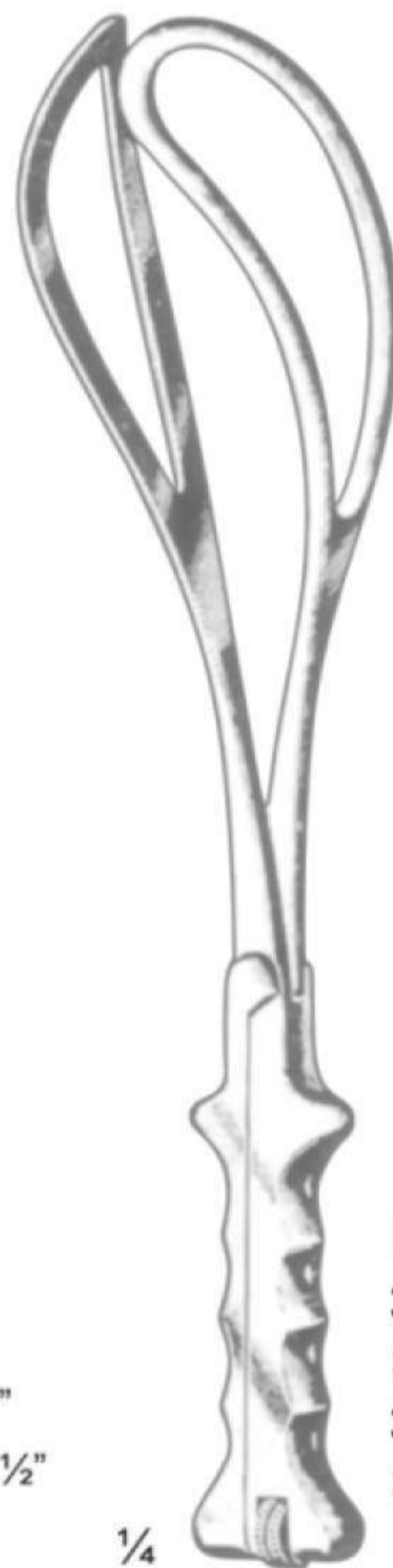

Elliot
392-3198
32.0 cm / 12½"
392-3199
38.0 cm / 15"



Mc Lean
392-3200
36.0 cm / 14"

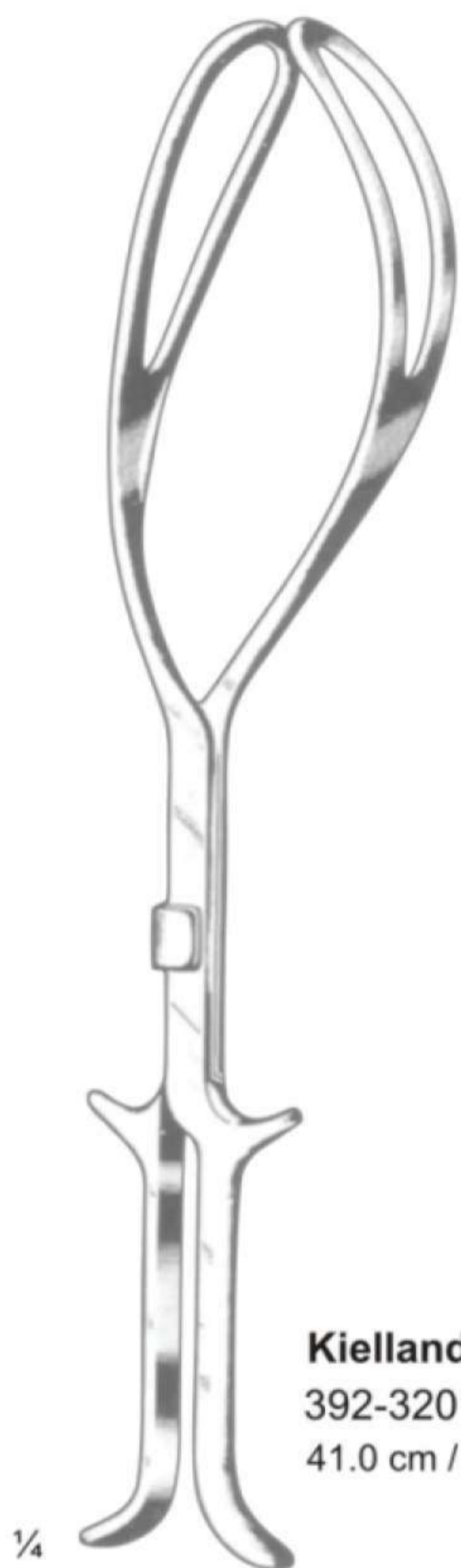

Kielland
392-3201
41.0 cm / 16"



Kielland-Luikart
392-3202
40.0 cm / 15¾"



Piper
392-3203
44.0 cm / 17¼"

Scalp Flap Forceps, Elevating Spoon, Etc.

393

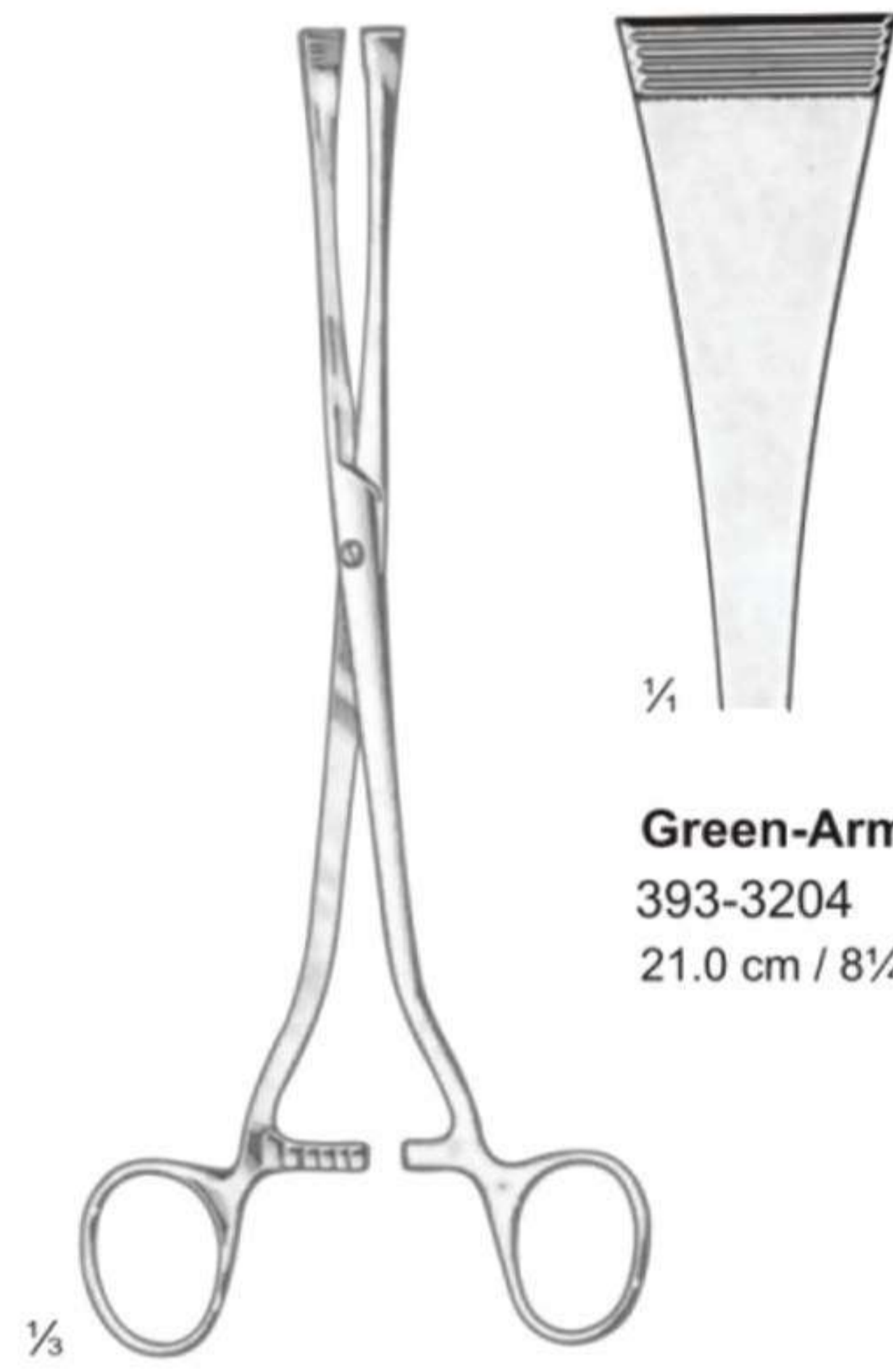

Green-Armytage
393-3204
21.0 cm / 8 1/4"



Sellheim
393-3205
28.0 cm / 11"

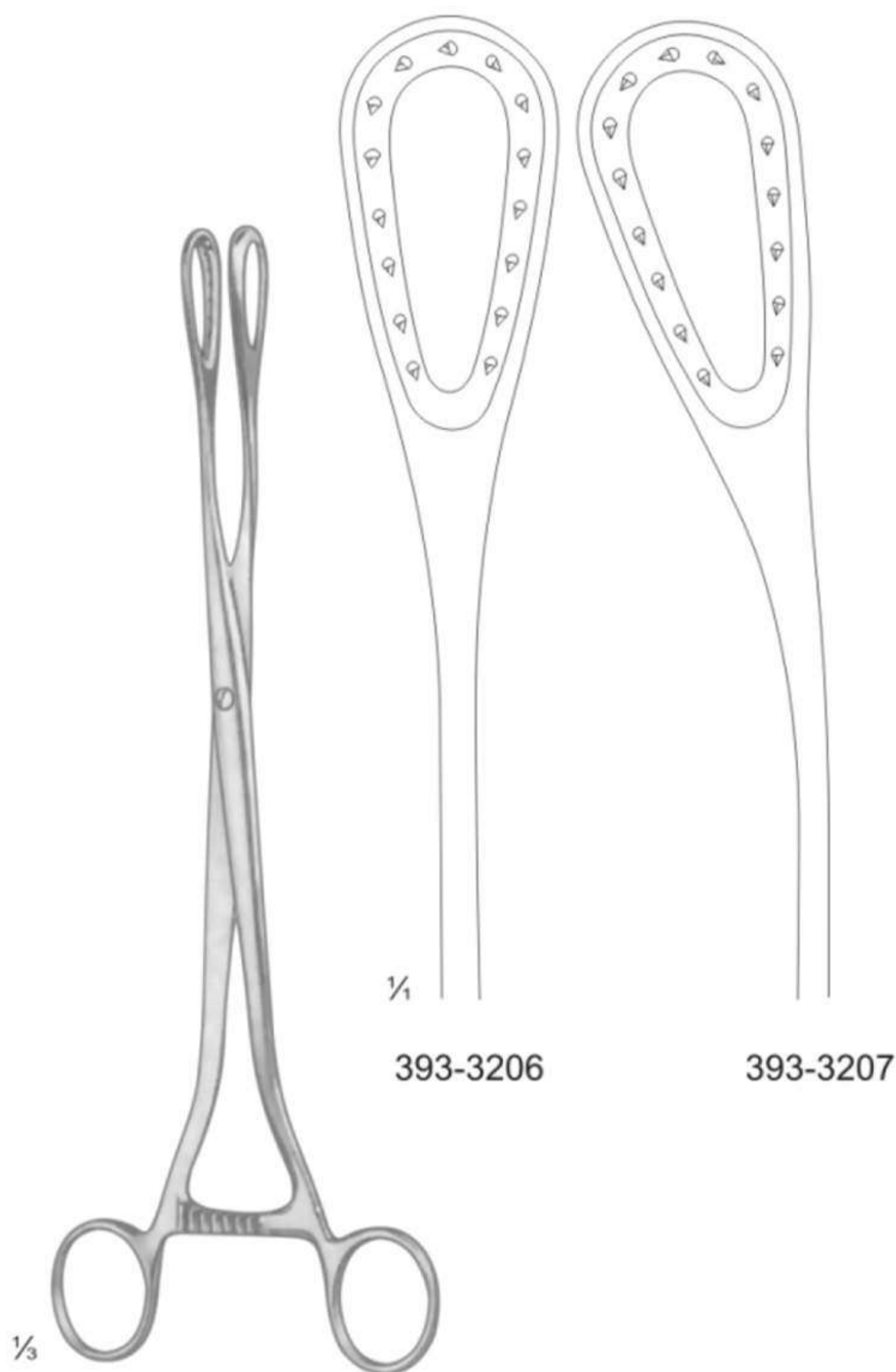

Saenger
27.0 cm / 10 1/2"

1/3
393-3206

393-3207



Winter
28.0 cm / 11"

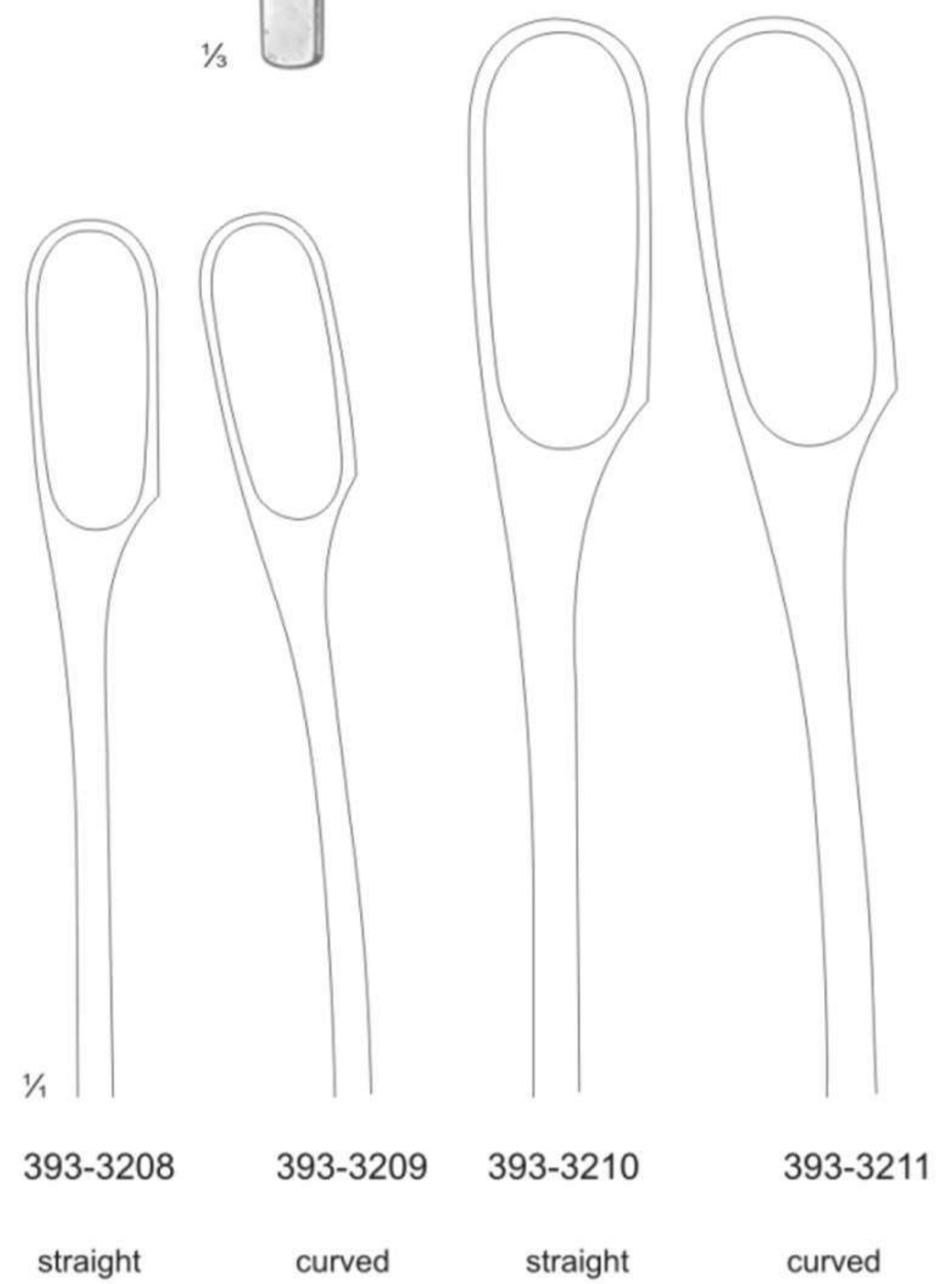

393-3208
straight

393-3209
curved

393-3210
straight

393-3211
curved



VIKTOR

SURGICAL INSTRUMENTS

Head Office:

533 Keswick Ct Rocheter Hills Michigan USA 48306

UAE Office:

NexGen Gadgets FZE, SM-Oce-C1- 518G, Ajman Free Zone

South East Asia Office:

324/34 Samprawuth Rd, Bangna, Bangna Bangkok 10260

Tel. : +662 107 4183

Mr.Tony +661 599 6754

E-mail : tony@viktormedical.com